

MG3631A/MG3632A
Synthesized Signal Generator
Operation Manual

Sixth Edition

Read this manual before using the equipment.
Keep this manual with the equipment.

SEP.
2002

ANRITSU CORPORATION

Document No.: M-W0643AE-6.0

Safety Symbols

To prevent the risk of personal injury or loss related to equipment malfunction, Anritsu Corporation uses the following safety symbols to indicate safety-related information. Insure that you clearly understand the meanings of the symbols **BEFORE** using the equipment.

Symbols used in manual

- DANGER** This indicates a very dangerous procedure that could result in serious injury or death if not performed properly.
- WARNING** This indicates a hazardous procedure that could result in serious injury or death if not performed properly.
- CAUTION** This indicates a hazardous procedure or danger that could result in light-to-severe injury, or loss related to equipment malfunction, if proper precautions are not taken.

Safety Symbols Used on Equipment and in Manual

(Some or all of the following five symbols may not be used on all Anritsu equipment. In addition, there may be other labels attached to products which are not shown in the diagrams in this manual.) The following safety symbols are used inside or on the equipment near operation locations to provide information about safety items and operation precautions. Insure that you clearly understand the meanings of the symbols and take the necessary precautions **BEFORE** using the equipment.



This indicates a prohibited operation. The prohibited operation is indicated symbolically in or near the barred circle.



This indicates an obligatory safety precaution. The obligatory operation is indicated symbolically in or near the circle.



This indicates warning or caution. The contents are indicated symbolically in or near the triangle.



This indicates a note. The contents are described in the box.



These indicate that the marked part should be recycled.

MG3631A/MG3632A Synthesized Signal Generator Operation Manual

October 1991 (First Edition)
March 1997 (Sixth Edition)

Copyright © 1991 – 1997 by Anritsu Corporation

All rights reserved. No part of this manual may be reproduced without the prior written permission of Anritsu Corporation.

The contents of this manual may be changed without prior notice.

Printed in Japan

For Safety

WARNING



Repair

WARNING

Falling Over

Battery Fluid

1. Always refer to the operation manual when working near locations at which the alert mark shown on the left is attached. If the operation, etc., is performed without heeding the advice in the operation manual, there is a risk of personal injury. In addition, the equipment performance may be reduced.

Moreover, this alert mark is sometimes used with other marks and descriptions indicating other dangers.

2. When supplying power to this equipment, connect the accessory 3-pin power cord to a 3-pin grounded power outlet. If a grounded 3-pin outlet is not available, before supplying power to the equipment, use a conversion adapter and ground the green wire, or connect the frame ground on the rear panel of the equipment to ground. If power is supplied without grounding the equipment, there is a risk of receiving a severe or fatal electric shock.

3. This equipment cannot be repaired by the user. DO NOT attempt to open the cabinet or to disassemble internal parts. Only Anritsu-trained service personnel or staff from your sales representative with a knowledge of electrical fire and shock hazards should service this equipment. There are high-voltage parts in this equipment presenting a risk of severe injury or fatal electric shock to untrained personnel. In addition, there is a risk of damage to precision parts.

4. This equipment should be used in the correct position. If the cabinet is turned on its side, etc., it will be unstable and may be damaged if it falls over as a result of receiving a slight mechanical shock.

5. DO NOT short the battery terminals and never attempt to disassemble it or dispose of it in a fire. If the battery is damaged by any of these actions, the battery fluid may leak.

This fluid is poisonous.

DO NOT touch it, ingest it, or get in your eyes. If it is accidentally ingested, spit it out immediately, rinse your mouth with water and seek medical help. If it enters your eyes accidentally, do not rub your eyes, irrigate them with clean running water and seek medical help. If the liquid gets on your skin or clothes, wash it off carefully and thoroughly.

For Safety

CAUTION

Changing Fuse

CAUTION 

1. Before changing the fuses, ALWAYS remove the power cord from the poweroutlet and replace the blown fuses. Always use new fuses of the type and rating specified on the fuse marking on the rear panel of the cabinet.

T□□□ A indicates a time-lag fuse.

□□□A or F□□□ A indicate a normal fusing type fuse.

There is risk of receiving a fatal electric shock if the fuses are replaced with the power cord connected.

2. Keep the power supply and cooling fan free of dust.
 - Clean the power inlet regularly. If dust accumulates around the power pins, there is a risk of fire.
 - Keep the cooling fan clean so that the ventilation holes are not obstructed. If the ventilation is obstructed, the cabinet may overheat and catch fire.
3. Use two or more people to lift and move this equipment, or use a trolley. There is a risk of back injury, if this equipment is lifted by one person.

Cleaning

 CAUTION/注意

>18kg

HEAVY WEIGHT/重量物

Equipment Certificate

Anritsu Corporation certifies that this equipment was tested before shipment using calibrated measuring instruments with direct traceability to public testing organizations recognized by national research laboratories including the Electrotechnical Laboratory, the National Research Laboratory and the Communication Research laboratory, and was found to meet the published specifications.

Anritsu Warranty

Anritsu Corporation will repair this equipment free-of-charge if a malfunction occurs within 1 year after shipment due to a manufacturing fault, provided that this warranty is rendered void under any or all of the following conditions.

- The fault is outside the scope of the warranty conditions described in the operation manual.
- The fault is due to misoperation, misuse, or unauthorized modification or repair of the equipment by the customer.
- The fault is due to severe usage clearly exceeding normal usage.
- The fault is due to improper or insufficient maintenance by the customer.
- The fault is due to natural disaster including fire, flooding and earthquake, etc.
- The fault is due to use of non-specified peripheral equipment, peripheral parts, consumables, etc.
- The fault is due to use of a non-specified power supply or in a non-specified installation location.

In addition, this warranty is valid only for the original equipment purchaser. It is not transferable if the equipment is resold.

Anritsu Corporation will not accept liability for equipment faults due to unforeseen and unusual circumstances, nor for faults due to mishandling by the customer.

Anritsu Corporation Contact

If this equipment develops a fault, contact Anritsu Corporation or its representatives at the address in this manual.

(Blank)

Note 1:

1. The instrument is operable on a nominal voltage of 100 to 127 Vac or 200 to 240 Vac by changing the connections on the power transformer taps.

The voltage and current ratings are indicated on the rear panel when the instrument is shipped from the factory.

To operate on the other voltage, change the connections on the power supply transformer. The plate on the rear panel indicating the voltage and current ratings should be changed to the appropriate one. Order the plate from ANRITSU CORPORATION if needed.

2. In this manual, the power supply voltage and current ratings are represented by **Vac and ***A, respectively.
3. The relationship between power supply voltage and current rating is shown below.

Vac	*A
100 V/110 to 115 V/120 to 127 V	3.15 A
200 V/220 to 230 V/240 V	1.6 A

Note 2:

WARNINGS, CAUTIONS, Notes, and Explanatory footnotes are used in this manual. Their meanings are given below:

WARNING: WARNING is used when there is a personal injury hazard.

CAUTION: CAUTION is used when the equipment may be damaged.

Note: Note is used to provide information about exceptions, corrections, and restrictions.

Explanatory footnote: Explanatory footnotes provide comments on the same page as the text, figure or table. They are referenced by either an asterisk (*) or by combination of an asterisk and numeral.

Note 3:

STORAGE MEDIUM

This equipment stores data and programs using backed-up memories.

Data and programs may be lost due to improper use or failure.

ANRITSU therefore recommends that you back-up the memory.

ANRITSU CANNOT COMPENSATE FOR ANY MEMORY LOSS.

Please pay careful attention to the following points.

- Isolate the memory from static electricity.
- The battery life is about 7 years. Early battery replacement is recommended.

Note 4:

OPERATION KEY REPRESENTATIONS

The operation keys in the descriptions of the operating procedure are represented as shown below.

Representation example	Meaning
[LOCAL] [SHIFT] [6]	When only a key is shown in the operating procedure, it means press the key. Actions performed one or more times, such as [press several times], [press continuously], etc. are appended.
[LOCAL] [SHIFT] [6]	As a rule, key representations in the text are enclosed in [].
Lamp	
On	● 1 kHz Lighting of the lamp is presented by ●.
Off	○ 1 kHz Turning off of the lamp is represented by ○.

CE Marking

Anritsu affix the CE Conformity Marking on the following product (s) accordance with the Council Directive 93/68/EEC to indicate that they conform with the EMC directive of the European Union (EU).

CE Conformity Marking



1. Product Name/Model Name

Product Name: Synthesized Signal Generator

Model Name: MG3631A and MG3632A

2. Applied Directive

EMC: Council Directive 89/336/EEC

Safety: Council Directive 73/23/EEC

3. Applied Standards

EMC:

Electromagnetic radiation:

EN55011 (ISM, Group 1, Class A equipment)

Immunity:

EN50082-1

IEC801-2 (ESD) 4 kVCD, 8 kVAD

IEC801-3 (Rad.) 3 V/m

IEC801-4 (EFT) 1 kV

Performance Criteria*

B

A

B

*: Performance Criteria

A: No performance degradation or function loss

B: Self-recovered temporary degradation of performance or temporary loss of function

Safety: EN61010-1 (Installation Category II, Pollution Degree 2)

(Blank)

Power Line Fuse Protection

For safety, Anritsu products have either one or two fuses in the AC power lines as requested by the customer when ordering.

Single fuse: A fuse is inserted in one of the AC power lines.

Double fuse: A fuse is inserted in each of the AC power lines.

Example 1: An example of the single fuse is shown below:

Fuse Holder

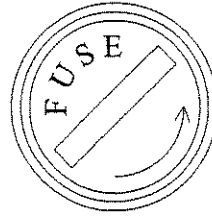

Example 2: An example of the double fuse is shown below:

Fuse Holders

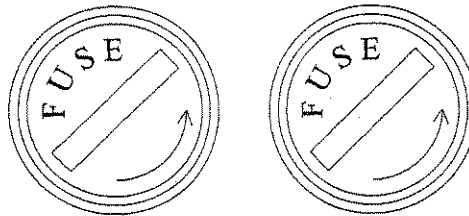

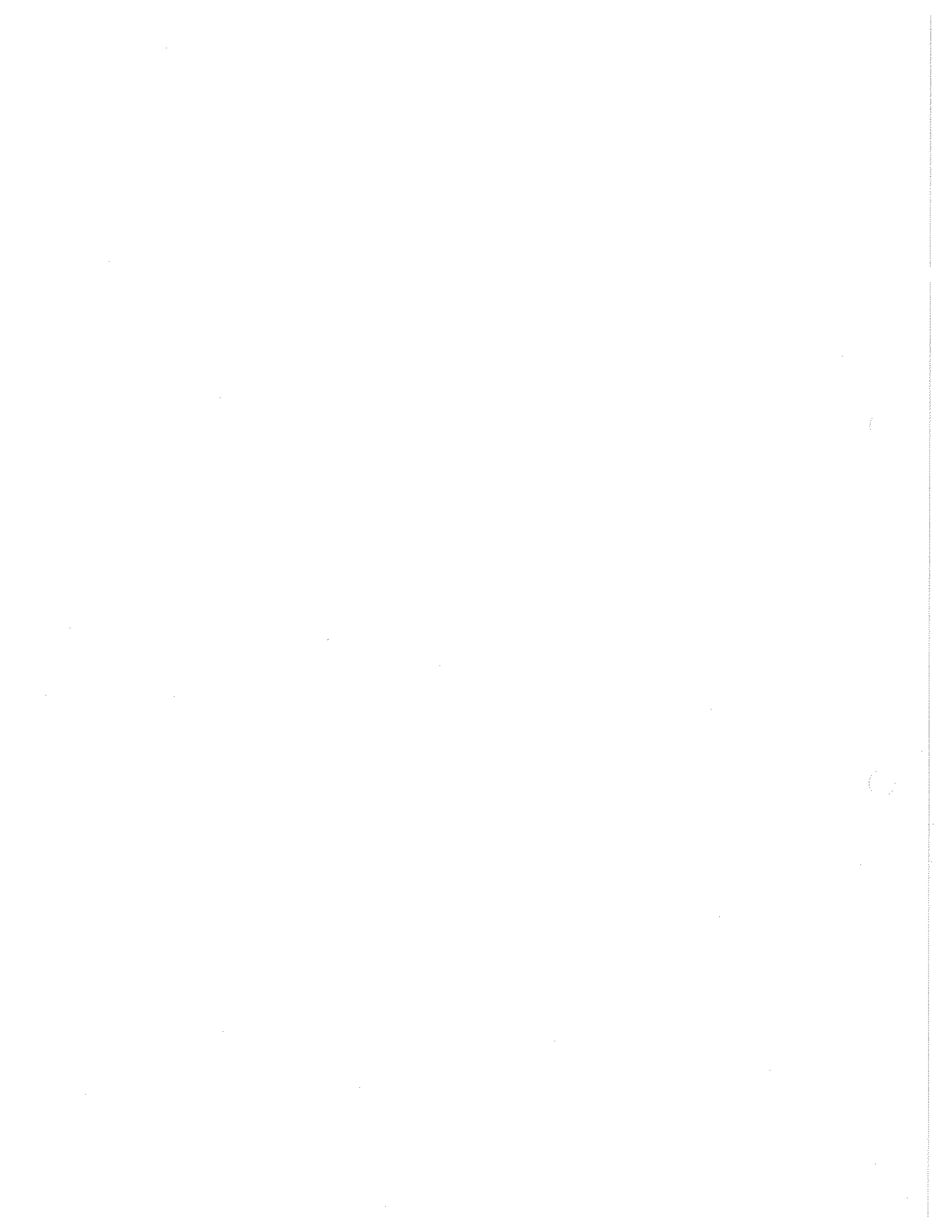

TABLE OF CONTENTS

For Safety		iii
SECTION	1	GENERAL	1-1
	1.1	Product Outline	1-1
	1.2	Operation Manual	1-2
	1.3	Composition	1-3
	1.3.1	Standard composition	1-3
	1.3.2	Options	1-4
	1.4	Optional Accessories and Peripheral Equipment	1-5
	1.5	Specifications	1-7
SECTION	2	PRECAUTION	2-1
	2.1	Installation Precautions	2-1
	2.1.1	Installation site environmental conditions	2-1
	2.1.2	Rack mounting	2-2
	2.2	Power Supply Safety Measures	2-2
	2.2.1	Protective grounding	2-2
	2.2.2	Fuse replacement	2-3
SECTION	3	PANEL LAYOUT AND PREPARATION	3-1
	3.1	Description of Front and Rear Panels	3-1
	3.2	Power On	3-11
	3.2.1	~LINE ON/OFF on rear panel	3-11
	3.2.2	POWER ON/STBY on front panel	3-12
	3.3	Preparation Before Operation	3-13
	3.3.1	Using internal reference oscillator	3-13
	3.3.2	Using external reference oscillator	3-14
	3.4	Reproducing Set Parameters	3-15
	3.5	Initialization	3-16
	3.6	Basic Operation	3-17
	3.6.1	Setting carrier frequency	3-17
	3.6.2	Setting output level	3-17
	3.6.3	Setting modulation	3-18
	3.6.4	Storing in and recalling from memory	3-18

SECTION	4	OPERATING INSTRUCTIONS	4-1
	4.1	Setting Carrier Frequency	4-1
	4.1.1	Setting frequency using data keys	4-1
	4.1.2	Setting frequency using increment step key	4-2
	4.1.3	Setting frequency using rotary knob	4-3
	4.1.4	Displaying relative frequency	4-4
	4.1.5	Frequency offset setting mode	4-5
	4.2	Setting Output Level	4-7
	4.2.1	Displaying open-circuit voltage and terminal voltage	4-8
	4.2.2	Output level setting using data keys	4-8
	4.2.3	Output level setting using increment step key	4-9
	4.2.4	Output level setting using rotary knob	4-10
	4.2.5	Output level setting continuous variable mode	4-11
	4.2.6	Displaying relative level	4-15
	4.2.7	Output level offset setting mode	4-16
	4.2.8	Turning output signal ON/OFF	4-17
	4.2.9	Operating and releasing reverse power protective circuit (RPP)	4-18
	4.3	Setting Modulation Functions	4-20
	4.3.1	Outline of modulation setting procedure	4-21
	4.3.2	Setting FM frequency deviation	4-24
	4.3.3	Setting AM modulation	4-28
	4.3.4	Setting the frequency of AF oscillator (option)	4-31
	4.3.5	External modulation signal	4-35
	4.3.6	Modulation output	4-37
	4.4	Function memory	4-38
	4.4.1	Storing in memory	4-39
	4.4.2	Recalling memory contents	4-40
	4.4.3	Memory skip setting	4-41
	4.4.4	Memory clear	4-42
	4.5	Other Functions	4-43
	4.5.1	Shift key function	4-43
	4.5.2	Special functions	4-46
	4.6	Status	4-49
	4.6.1	Error status	4-51
	4.6.2	UNCAL status	4-54
	4.7	Message Display by 7-Segment Display	4-56

SECTION	5	MEASUREMENT	5-1
	5.1	Measuring Sensitivity	5-1
	5.1.1	Measuring 20 dB NQ sensitivity	5-1
	5.1.2	Measuring 12 dB SINAD sensitivity	5-3
	5.2	Measuring One-Signal Selectivity	5-4
	5.2.1	Using 20 dB NQ method to measure FM receiver selectivity	5-5
	5.2.2	Measuring spurious response	5-7
	5.3	Measuring Two-Signal Selectivity	5-9
	5.3.1	Measuring blocking effect of FM receiver	5-9
	5.3.2	Measuring cross-modulation characteristics	5-12
SECTION	6	GP-IB	6-1
	6.1	Introduction	6-1
	6.1.1	Outline	6-1
	6.1.2	Specifications	6-2
	6.2	GP-IB Address	6-7
	6.2.1	Precautions before using GP-IB	6-7
	6.3	Device-Message General Format	6-9
	6.3.1	Symbolic notation of device messages	6-10
	6.3.2	Explaining each device message element	6-11
	6.3.3	Type of device messages	6-18
	6.3.4	General format of MG3631A/MG3632A device messages	6-19
	6.4	Details of Device Messages	6-21
	6.4.1	Setting frequency	6-21
	6.4.2	Setting output level	6-24
	6.4.3	Setting FM modulation	6-29
	6.4.4	Setting AM modulation	6-31
	6.4.5	Setting FM deviation and AM modulation factor using up [^]/down [v] keys	6-33
	6.4.6	Setting AF modulation frequency	6-35
	6.4.7	Setting external modulation input	6-37
	6.4.8	Memory setting	6-38
	6.4.9	Other setting	6-40
	6.5	Sample Programs	6-42
	6.6	Control by MG3633A Program Code	6-46

SECTION	7	PERFORMANCE TESTS	7-1
	7.1	Introduction	7-1
	7.2	Equipment Required for Performance Tests	7-1
	7.3	Performance Tests	7-2
	7.3.1	Output frequency	7-2
	7.3.2	Output-level frequency characteristic	7-3
	7.3.3	Output-level accuracy	7-5
	7.3.4	FM deviation and FM distortion	7-8
	7.3.5	AM modulation factor and AM distortion	7-9
	7.4	Service	7-11
SECTION	8	CALIBRATION	8-1
	8.1	Introduction	8-1
	8.2	Equipment Required for Calibration	8-1
	8.3	Calibration	8-2
	8.3.1	Reference oscillator frequency calibration using frequency standard	8-2
	8.3.2	Reference oscillator frequency accuracy calibration using counter	8-4
	8.3.3	Calibrating frequency accuracy at DM-FM modulation	8-5
SECTION	9	STORAGE AND TRANSPORTATION	9-1
	9.1	Daily Servicing and Preventive Maintenance	9-1
	9.2	Storage Precautions	9-1
	9.2.1	Precautions before storage	9-2
	9.2.2	Recommended storage conditions	9-2
	9.3	Repacking and Transportation	9-2
	9.3.1	Repacking	9-2
	9.3.2	Transportation	9-2
APPENDIX	A	DEVICE MESSAGE IN ALPHABETIC ORDER	A-1
APPENDIX	B	UNIVERSAL ASCII* CODE TABLE	B-1
APPENDIX	C	GP-IB COMMAND COMPARISON TABLE BETWEEN PACKET AND PC-9801	C-1
APPENDIX	D	IEEE STANDARD ABBREVIATIONS INDEX	D-1
APPENDIX	E	PANEL LAYOUT	E-1

SECTION 1

GENERAL

This section provides an outline of this manual and describes the standard composition, optional accessories, peripheral devices for expanding its functions and the specifications of the MG3631A/MG3632A Synthesized Signal Generator.

1.1 Product Outline

The MG3631A/MG3632A Synthesized Signal Generators are provided with amplitude and frequency modulation in the frequency range of 0.1 to 1040 MHz and 0.1 to 2080 MHz, respectively. Since the MG3631A/MG3632A also has excellent basic performance in regards to frequency stability, output level accuracy, and signal purity, they can be used in a wide range of applications and are suitable for performance evaluation of various receivers (mobile radio, paper, AM/FM radio, etc.), or as the general-purpose signal sources. Furthermore, memory functions and a GP-IB interface are provided as a standard. Therefore, they are useful for elimination or reduction of labor and automation for measurement.

1.2 Operation Manual

This operation manual contains 9 sections and 4 appendixes. The format and outline of each section is described below.

Table 1-1

Section	Title	Contents
1	GENERAL	Description of the MG3631A/MG3632A (standard configuration, specifications), optional accessories and peripheral equipment, and outline of operation manual.
2	PRECAUTION	Operations to be performed before powering-up the MG3631A/MG3632A
3	PANEL LAYOUT AND PREPARATION	Layout, function and method of preparative operation of components such as keys, connectors, knobs, and indicators on both the front and rear panels.
4	OPERATING INSTRUCTIONS	Details of manual operation (local operation) of the front and rear panels. (Except for remote control by GP-IB)
5	MEASUREMENT	Methods for measuring sensitivity and selectivity of receivers as typical measurement examples using a signal generator
6	GP-IB	Remote-control operational procedure and description of device messages
7	PERFORMANCE TEST	Measuring instrument setup, and procedures required for performance testing
8	CALIBRATION	Measuring instrument setup, and procedures required for calibration
9	STORAGE AND TRANSPORTATION	Daily maintenance, long period storage, re-packing and transportation
APPENDIX	A	Device message in alphabetical order
	B	Universal ASCII code table
	C	GP-IB command comparison table between PACKET (Anritsu) and PC9801 (NEC, in Japan)
	D	IEEE standard abbreviations index
	E	Front and rear panel layout

1.3 Composition

This paragraph describes the standard configuration of the MG3631A/MG3632A and the options for expanding its functions.

1.3.1 Standard composition

The standard configuration of the MG3631A/MG3632A is listed in the table below.

Table 1-2 Standard Composition

Item	No.	Model number/ Order number	Name	Qty.	Remarks
Instru- ment	1	MG3631A/ MG3632A	Synthesized Signal Generator	1	
Accessories supplied	2	J0576B	50Ω coaxial cable	1	Approx, 1m (N-P · 5D-2W · N-P), for RF output cable
	3	J0127A	50Ω coaxial cable	1	Approx. 1m (BNC-P·RG- 58A/U·BNC-P), for modulation signal cable
	4	J0017	Power cord	1	Approx. 2.5m
	5	B0325	GP-IB shield cap	1	Guaranteed a leakage
	6	F0012 (3.15A) or F0021 (1.6A)	AC fuse	2	For 100 V system For 200 V system
	7	W0643AE	Operation manual	1	
	8	W0643BE	Service manual	1	

1.3.2 Options

MG3631A/MG3632A options (sold separately) are listed in the table below.

Table 1-3 Options (Sold separately)

Option No.	Model number/ Order number	Name	Remarks
01	MG3631A/ MG3632A-01	Reference Crystal Oscillator	Frequency: 10 MHz Start-up characteristics: $\leq 1 \times 10^{-7}/\text{day}$ (after 30-minute operation) $\leq 5 \times 10^{-8}/\text{day}$ (after 60-minute operation) Aging rate: $\leq 2 \times 10^{-8}/\text{day}$ (after 24-hour operation) Temperature characteristics: $\leq \pm 5 \times 10^{-8}$ (at 0° to 50°C)
02	MG3631A/ MG3632A-02	Reference Crystal Oscillator	Frequency: 10 MHz Start-up characteristics: $\leq 7 \times 10^{-8}/\text{day}$ (after 30-minute operation) $\leq 3 \times 10^{-8}/\text{day}$ (after 60-minute operation) Aging rate: $\leq 5 \times 10^{-9}/\text{day}$ (after 24-hour operation) Temperature characteristics: $\leq \pm 5 \times 10^{-8}$ (at 0° to 50°C)
03	MG3631A/ MG3632A-03	Reference Crystal Oscillator	Frequency: 10 MHz Start-up characteristics: $\leq 2 \times 10^{-8}/\text{day}$ (after 60-minute operation) Aging rate: $\leq 2 \times 10^{-9}/\text{day}$ (after 24-hour operation) Temperature characteristics: $\leq \pm 1.5 \times 10^{-8}$ (at 0° to 50°C)
04	MG3631A/ MG3632A-04	AF Oscillator	Frequency: 20 Hz to 100 kHz Resolution: 0.1 Hz Accuracy: ± 100 ppm
05	MG3631A/ MG3632A-41	Band limited at harmonics specification	≤ -30 dBc (10MHz to 1040MHz) for MG3631A ≤ -30 dBc (10MHz to 2080MHz) for MG3632A

1.4 Optional Accessories and Peripheral Equipment

The major optional accessories and peripheral equipment for the MG3631A/MG3632A are listed below. The items listed are sold separately.

Table 1-4 Optional Accessories (Sold separately)

Model number/ Order number	Name	Remarks
MP51A MP52A	Impedance Conversion Pad	For matching the MG3631A/MG3632A impedance to that of the measuring system (0 to 200 MHz). MP51A (from a 75Ω system to a 50Ω system) MP52A (from a 50Ω system to a 75Ω system)
MP614A	50Ω↔75Ω Impedance Transformer	For matching the MG3631A/MG3632A impedance to that of a 75Ω measuring device (10 to 1200 MHz)
Z-164A Z-164B	T-pad	For measuring two-signal characteristics, Z-164A for 50Ω, Z-164B for 75Ω
MP659A MA1612A	Four-port Junction Pad	For measuring three-signal characteristics MP659A (40 to 1000 MHz) MA1612A (5 to 3000 MHz)
MP721□	Fixed Attenuator	Nominal attenuations: 3, 6, 10 to 60 dB (10 dB steps), covering the frequency range of DC to 12.4 GHz. For level adjustment and improvement of impedance characteristics.
B0047	Rack flange kit	

Table 1-5 Peripheral Equipment (Sold separately)

Model number/ Order number	Name	Remarks
MS2702A	Spectrum Analyzer	For automated transmitter/receiver measurements 100 Hz to 24.5 GHz
MS616B	Modulation Analyzer	For automated transmitter/receiver measurements 150 kHz to 3 GHz
MN3650A/B/C	Digital Modulator	Digital modulated signal (GMSK, $\pi/4$ DQPSK) is obtained.
MA1610A	Pulse Modulator	For generating a pulse-modulated RF signal
MA8010A	Remote Controller	Remote-controls the output frequency, level, and memory recall of the MG3631A/MG3632A, manually.

1.5 Specifications

The MG3631A/MG3632A specifications are listed below.

Specifications (1/5)

Carrier frequency	Range	100 kHz to 1040 MHz setting range: 0 to 1040 MHz (MG3631A), 100 kHz to 2080 MHz setting range: 0 to 2080 MHz (MG3632A)			
	Resolution	10 Hz			
	Accuracy	Same as that for the reference oscillator, except in DC-FM mode			
	Internal reference oscillator *1	Frequency	10 MHz		
		Aging rate	$\leq \pm 2 \times 10^{-7}/\text{day}$		
		Temperature characteristics	$\pm 1 \times 10^{-6}$ (0° to 50°C)		
	External reference signal input	10 MHz \pm 10 ppm, TTL level, BNC connector on rear panel			
	Reference signal output	10 MHz, TTL level, BNC connector on rear panel			
Switching time	Elapsed time from last command until frequency has stabilized to within ± 500 Hz of set frequency during remote operation: ≤ 150 ms				
Output level	Range	-143 to +13 dBm			
	Unit	dBm, dB μ , V, mV, μ V (Terminated and open voltages are selected in units of dB μ , V, mV or μ V)			
	Resolution	0.1 dB			
	Frequency response	± 0.5 dB at 0 dBm (≤ 1040 MHz) ± 1 dB at 0 dBm (> 1040 MHz, only for MG3632A)			
	Level accuracy	Frequency	100 kHz \leq to ≤ 1040 MHz	1040 MHz < to ≤ 1700 MHz, only for MG3632A	1700 MHz <, only for MG3632A
		Output level			
		+13 to -33 dBm	± 1 dB	± 1.5 dB	± 1.5 dB
		-33.1 to -108 dBm	± 1.5 dB	± 2.5 dB	± 3 dB
-108.1 to -123 dBm		± 1.5 dB	± 2.5 dB	± 4 dB	
-123.1 to -133 dBm	± 3 dB	± 4 dB	± 4 dB		
Impedance	50 Ω , N-type connector VSWR: ≤ 1.5 (≤ 1040 MHz, ≤ -3 dBm) ≤ 1.8 (> 1040 MHz, ≤ -3 dBm, only for MG3632A)				

*1 Aging rates up to $2 \times 10^{-9}/\text{day}$ are available as options 01 to 03.

Specifications (2/5)

Output level (Cont.)	Switching time	Elapsed time from last command until output level is stabilized within ± 0.5 dB of the last value during remote operation: ≤ 150 ms																					
	Interference radiation	$\leq 0.3 \mu\text{V}$ (Terminated with 50Ω load, measured 25 mm from front panel with a two-turn 25 mm diameter loop antenna. 10 MHz reference signal excluded with Option 01/02/03)																					
Signal purity	Spurious	In CW mode: f_c: carrier frequency																					
		Harmonics (2nd, 3rd)	≤ -30 dBc Band limited by Option 41 ≤ -30 dBc (2nd, 3rd) (10MHz $\leq f_c \leq 1040$ MHz) for MG3631A ≤ -30 dBc (2nd, 3rd) (10MHz $\leq f_c \leq 2080$ MHz) for MG3632A																				
		Sub-harmonics ($f_c/2, 3f_c/2, 5f_c/2$)	None (at ≤ 1040 MHz) ≤ -30 dBc (at > 1040 MHz for MG3632A)																				
		Non-harmonics	≤ -60 dBc ($f_c < 130$ MHz, ≥ 5 kHz offset) ≤ -66 dBc (130 MHz $\leq f_c < 520$ MHz, ≥ 5 kHz offset) ≤ -60 dBc (520 MHz $\leq f_c \leq 1040$ MHz, 5 kHz offset) ≤ -54 dBc ($f_c > 1040$ MHz, ≥ 5 kHz offset, only for MG3632A)																				
	SSB phase noise	In CW mode: <table border="1" style="width: 100%; border-collapse: collapse; margin-top: 10px;"> <thead> <tr> <th style="text-align: center;">Offset frequency</th> <th style="text-align: center;">10 kHz</th> <th style="text-align: center;">20 kHz</th> </tr> </thead> <tbody> <tr> <td style="text-align: center;">Frequency</td> <td></td> <td></td> </tr> <tr> <td style="text-align: center;">10 MHz $\leq f_c < 130$ MHz</td> <td style="text-align: center;">≤ -124 dBc/Hz</td> <td style="text-align: center;">≤ -125 dBc/Hz</td> </tr> <tr> <td style="text-align: center;">130 MHz $\leq f_c < 260$ MHz</td> <td style="text-align: center;">≤ -133 dBc/Hz</td> <td style="text-align: center;">≤ -134 dBc/Hz</td> </tr> <tr> <td style="text-align: center;">260 MHz $\leq f_c < 520$ MHz</td> <td style="text-align: center;">≤ -130 dBc/Hz</td> <td style="text-align: center;">≤ -131 dBc/Hz</td> </tr> <tr> <td style="text-align: center;">520 MHz $\leq f_c \leq 1040$ MHz</td> <td style="text-align: center;">≤ -124 dBc/Hz</td> <td style="text-align: center;">≤ -125 dBc/Hz</td> </tr> <tr> <td style="text-align: center;">1040 MHz $< f_c$ (only for MG3632A)</td> <td style="text-align: center;">≤ -118 dBc/Hz</td> <td style="text-align: center;">≤ -119 dBc/Hz</td> </tr> </tbody> </table>		Offset frequency	10 kHz	20 kHz	Frequency			10 MHz $\leq f_c < 130$ MHz	≤ -124 dBc/Hz	≤ -125 dBc/Hz	130 MHz $\leq f_c < 260$ MHz	≤ -133 dBc/Hz	≤ -134 dBc/Hz	260 MHz $\leq f_c < 520$ MHz	≤ -130 dBc/Hz	≤ -131 dBc/Hz	520 MHz $\leq f_c \leq 1040$ MHz	≤ -124 dBc/Hz	≤ -125 dBc/Hz	1040 MHz $< f_c$ (only for MG3632A)	≤ -118 dBc/Hz
Offset frequency	10 kHz	20 kHz																					
Frequency																							
10 MHz $\leq f_c < 130$ MHz	≤ -124 dBc/Hz	≤ -125 dBc/Hz																					
130 MHz $\leq f_c < 260$ MHz	≤ -133 dBc/Hz	≤ -134 dBc/Hz																					
260 MHz $\leq f_c < 520$ MHz	≤ -130 dBc/Hz	≤ -131 dBc/Hz																					
520 MHz $\leq f_c \leq 1040$ MHz	≤ -124 dBc/Hz	≤ -125 dBc/Hz																					
1040 MHz $< f_c$ (only for MG3632A)	≤ -118 dBc/Hz	≤ -119 dBc/Hz																					
Residual AM	$\leq 0.03\%$ rms at ≥ 500 kHz (demodulation band: 50 Hz to 15 kHz)																						
Residual FM	At demodulation band 0.3 to 3 kHz: ≤ 4 Hzrms (≥ 10 MHz, < 130 MHz) ≤ 1 Hzrms (≥ 130 MHz, < 260 MHz) ≤ 2 Hzrms (≥ 260 MHz, < 520 MHz) ≤ 4 Hzrms (≥ 520 MHz, ≤ 1040 MHz) ≤ 8 Hzrms (> 1040 MHz) (only for MG3632A) At demodulation band 50 Hz to 15 kHz: ≤ 10 Hzrms (≥ 10 MHz, < 130 MHz) ≤ 3 Hzrms (≥ 130 MHz, < 260 MHz) ≤ 5 Hzrms (≥ 260 MHz, < 520 MHz) ≤ 10 Hzrms (≥ 520 MHz, ≤ 1040 MHz) ≤ 20 Hzrms (> 1040 MHz) (only for MG3632A)																						

Specifications (3/5)

Amplitude modulation	Range	0 to 100%				
	Resolution	1%				
	Internal modulation frequency	Fixed frequency	400 Hz, 1 kHz			
		Variable frequency	0.1 Hz to 100 kHz, 0.1 Hz resolution			
		Frequency accuracy	100 ppm			
	Accuracy	± (5% of indicated value + 2%) [at ≥ 0.4 MHz, ≤ +7 dBm, 0 to 90%, internal 1 kHz, and demodulation band 0.3 to 3 kHz]				
	Frequency response	At ≤ +7 dBm, ±1 dB bandwidth				
		Lower modulation frequency limit	20 Hz (EXT AC mode) DC (EXT DC mode)			
		Upper modulation frequency limit	Carrier Frequency	Modulation factor	0 to 30%	30.1 to 80%
			$0.4 \text{ MHz} \leq f_c < 2 \text{ MHz}$		10 kHz	5 kHz
$2 \text{ MHz} \leq f_c$			20 kHz	15 kHz		
External modulation	Input level	Approx. $2V_{p-p}/600\Omega$				
	Input impedance	Nominal 600Ω				
Distortion	$\leq -40 \text{ dB}$ (at ≥ 0.4 MHz, ≤ +7 dBm, internal 1 kHz, 30%) $\leq -30 \text{ dB}$ (at ≥ 0.4 MHz, ≤ +7 dBm, internal 1 kHz, 80%)					
Incidental FM	≤ 200 Hz peak (at ≥ 0.4 MHz, < +7 dBm, internal 1 kHz, 30%, demodulation band 0.3 to 3 kHz)					
Frequency modulation	Range	0 to 200 kHz ($0.5 \text{ MHz} \leq f_c < 130 \text{ MHz}$) 0 to 100 kHz ($130 \text{ MHz} \leq f_c < 260 \text{ MHz}$) 0 to 200 kHz ($260 \text{ MHz} \leq f_c$)				
	Resolution	10 Hz (0 to 9.99 kHz deviation) 100 Hz (10 to 99.9 kHz deviation) 1 kHz (100 to 200 kHz deviation)				
	Accuracy	± (5% of indicated value + 20 Hz), (at ≥ 0.5 MHz, internal 1 kHz, demodulation band 0.3 to 3 kHz)				
	Frequency response	At ≥ 0.5 MHz, ±1 dB bandwidth				
Frequency range		EXT AC mode: 20 Hz to 100 kHz EXT DC mode: DC to 100 kHz				

Specifications (4/5)

Frequency modulation (Cont.)	External modulation	Input level	Approx. $2V_{p-p}/600\Omega$
		Input impedance	Nominal 600Ω
	Distortion	≤ -45 dB (at ≥ 0.5 MHz, AM 30%, internal 1 kHz, 3.5/22.5 kHz deviation)	
	Incidental AM	$\leq 0.4\%$ peak (at ≥ 0.5 MHz, AM30%, internal 1 kHz, 22.5 kHz deviation, 0.3 to 3 kHz demodulation band)	
	Carrier frequency accuracy in DC-FM mode	± 100 Hz during 3 minutes at 2. hour power-on and calibration (at 1000 MHz, FM 10 kHz)	
Internal modulation signal	Frequency range	400 Hz, 1 kHz 20 Hz to 100 kHz (Option 04)	
	Frequency accuracy	± 100 ppm	
Other function	Simultaneous modulation	Simultaneous modulation with each AM and FM setting is possible as shown below. AM: 1 kHz/EXT, 400 Hz/EXT, AF/EXT, 1 kHz/AF, 400 Hz/AF FM: 1 kHz/EXT, 400 Hz/EXT, AF/EXT, 1 kHz/AF, 400 Hz/AF (AF: AF Oscillator of Option 04)	
	Modulation signal output	Modulation signal is output when modulating Output level: $2 V_{p-p} \pm 20\%/600\Omega$	
	Modulation signal polarity	External-modulation-signal polarity can be changed.	
	Relative value display	Carrier frequency Output level	
	Continuously variable output level	Continuously variable within a 26 dB range of the set level with fixed 5 dB-step P-ATT value Linearity: ± 1 dB (at ALC attenuator output level > -7 dBm, $\leq +13$ dBm) ± 3 dB (at ALC attenuator output level ≥ -13 dBm, ≤ -7 dBm) , where ALC attenuator output level $+7$ dBm as reference	
	Memory	100 panel settings (store/recall)	
	Memory backup	Last settings are stored when power is turned off. The following contents are not backed-up: data during key input and GP-IB transfer, remote status, and Reverse Power Protector (RPP) operation status.	

Specifications (5/5)

Other function (Cont.)	GP-IB	All functions except POWER switch and LOCAL key can be controlled. Interface: SH0, AH1, T0, L4, TE0, SR0, RL1, PP0, DC1, DT0, C0, E2
	REMOTE	External controller can control some or all functions equal to those by front panel keys (however, except POWER switch and rotary knob). Controllable functions depends on the remote controller.
Reverse power protection	Maximum reverse input power	50 W (≤ 1040 MHz), 25W (> 1040 MHz), ± 50 Vdc
General	Ambient temperature, rated range of use	0° to 50°C
	Power	**Vac +10%/-15% (max. 250 Vac), 47.5 to 63 Hz, ≤ 125 VA
	Dimensions & weight	132.5H \times 426W \times 451D mm, ≤ 22 kg

SECTION 2 PRECAUTION

This section describes the preparatory work which must be performed before using the MG3631A/MG3632A Synthesized Signal Generator and the precautions relating to (1) installation and (2) power supply. For GP-IB cable connection, address setting, etc, see Section 6.

2.1 Installation Precautions

This paragraph describes the MG3631A/MG3632A Synthesized Signal Generator installation precautions and mechanical assembly procedure for mounting the MG3631A/MG3632A in a rack.

2.1.1 Installation site environmental conditions

(1) Location to avoid

The MG3631A/MG3632A operates normally at ambient temperatures of 0° to 50°C.

However, for best performance, do not use or store it in locations where:

- It may be subjected to strong vibrations
- It may be exposed to extreme humidity or dust
- It may be exposed to direct sunlight
- It may be exposed to explosive gases

To maintain stable measurement for a long time, in addition to meeting the conditions listed above, the MG3631A/MG3632A should be used at stable room temperatures and where the AC line voltage fluctuations are small.

CAUTION: *If the MG3631A/MG3632A is used at room temperature after being used or stored at a low temperature for a long time, condensation may occur inside the instrument which could cause short circuiting. Always ensure that the MG3631A/MG3632A is thoroughly dry before turning on the power.*

(2) Fan clearance

To prevent excessive temperature increase inside the MG3631A/MG3632A, a cooling fan is mounted on the rear panel. Leave a space of at least 10 cm between the rear panel and walls, peripheral devices, obstructions, etc. so that air flow is not obstructed. Do not use the MG3631A/MG3632A on its side.

2.1.2 Rack mounting

To mount the MG3631A/MG3632A in a rack, the optional rack mounting kit (sold separately) is necessary. Order the rack flange kit by using the order number B0047 (Table 1-4). Mounting instructions are supplied with the kit.

2.2 Power Supply Safety Measures

The MG3631A/MG3632A operates normally on a **Vac +10%/-15%, 47.5 to 63 Hz power supply. Turn on the AC power only after taking precautions against the following hazards.

- Electric shock
- Damage due to the abnormal power supply voltage
- Earth current

Therefore, observe the following safety measures before supplying AC power.

2.2.1 Protective grounding

(1) Grounding by 3-pole AC outlet

When a 3-pole (ground type 2-pole) AC outlet is available, the MG3631A/MG3632A frame is connected to earth potential when the power cord is plugged into the AC outlet. Therefore, the FG terminal (rear panel) does not have to be grounded.

(2) Grounding frame ground (FG) terminal

When a 3-pole AC outlet is not available, ground the FG terminal (on rear panel) directly to earth potential.

2.2.2 Fuse replacement

The MG3631A/MG3632A is supplied with two fuses rated as described in the Note 1 on the first page of this manual. The fuses are to be loaded inside the fuse holders.

If a fuse blows, locate the cause before replacing.

- WARNING:**
- *Before replacing a fuse, turn off the POWER switch and unplug the power cord from the AC outlet. Never replace a fuse with the power cord connected.*
 - *Before turning on the power after replacing a fuse, check the protective grounding described in paragraph 2.2.1 and check that the AC supply voltage is suitable. There may be an electric shock hazard if the power is turned on without the protective grounding. If the AC supply voltage is unsuitable, the equipment may be damaged. The fuse replacement procedure is described below.*

Step	Procedure
1	Set the POWER switch on the front panel to STBY and the ~LINE switch on the rear panel to OFF, and unplug the power cord from the AC outlet.
2	Turn the fuse-holder cap counterclockwise and remove the cap together with the fuse.
3	Remove the blown fuse from the cap and replace it with a spare fuse of the same rating.
4	Refit the cap and turn it clockwise until it will turn no further.

- CAUTION:**
- If there are no spare fuses, check that the replacement you obtain is of the same type, rated voltage and current as the original.*
 - *If the fuse is not the same type, it may not fit the holder, contact may be poor, or the fusing time may be too long.*
 - *If the rated voltage and current of the replacement fuse are too high and trouble reoccurs, the new fuse may not blow and the instrument could catch fire.*



SECTION 3

PANEL LAYOUT AND PREPARATION

This section describes the control functions on the MG3631A/MG3632A front and rear panels and provides preparative instructions. As a reference, front and rear panel fold-out illustrations are located in APPENDIX E.



3.1 Description of Front and Rear Panels

The front and rear panels are illustrated in the last page of this operation manual as Figs. E-1 and E-2 in APPENDIX E. The arrangement of keys, connectors, and displays on the operation panel can be referred to by the numbers in the following table.

No.	Related panel indication	Equipment explanation
1	<p style="text-align: center;">MEMORY</p> 	<p>Displays memory address when memory function is used.</p>
2	<p style="text-align: center;">MODULATION</p> 	<p>Displays the AM modulation factor during AM modulation or FM frequency deviation during FM modulation.</p> <p>Displays "MIX" when in the mode where the modulation factor or frequency deviation of the MIX modulation signal is set.</p> <p>Displays "INVS" when the polarity of an external modulation input is inverted and the modulation signal EXT is ON.</p>

The characters in {} are indicated in blue (the key corresponding to the shift key).

(Continued)

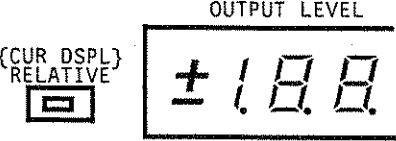
No.	Related panel indication	Equipment explanation
3		<ul style="list-style-type: none">● RELATIVE key: Used for displaying the relative frequency. When this key is pressed, the key LED lights and the display turns to relative frequency display mode. When the key is pressed again, the key LED goes out and the display returns to normal frequency display mode.● CUR DSPL key: Used for displaying the real output frequency during the relative frequency display or frequency offset mode. Press [SHIFT], then [RELATIVE]. While it is pressed, the real frequency continues to be displayed.
4		<p>Displays the carrier frequency or AF frequency. When in the AF frequency display mode, "AF" is displayed at the left edge of the display.</p> <p>In the frequency offset mode, "F" is displayed at the right edge of the display. Note that this display is also used to display various error messages.</p>
5		<ul style="list-style-type: none">● RELATIVE key: Used for displaying the relative level. When this key is pressed, the key LED lights and the display shows a relative level. When pressed again, the key LED goes out and the display returns to normal output level display mode.● CUR DSPL key: Used for displaying the real output level during the relative level display or level offset mode. Press [SHIFT], then [RELATIVE]. While it is pressed, the level continues to be displayed.

The characters in {} are indicated in blue (the key corresponding to the shift key).

(Continued)

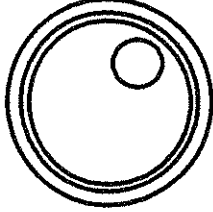
No.	Related panel indication	Equipment explanation
6	<p style="text-align: center;">OUTPUT LEVEL</p> <div style="border: 1px solid black; padding: 5px; display: inline-block;"><p style="margin: 0;">± 1888</p><p style="margin: 0; font-size: small;">dBm V EMF dBμ mV OFS dB μV CONT</p></div>	<p>Displays the output level. "EMF" is displayed while in the open-circuit voltage display mode.</p> <p>"CONT" is displayed while in the continuous mode.</p> <p>In the level offset mode, "OFS" is displayed.</p>
7	<p style="text-align: center;">OUTPUT</p> <div style="border: 1px solid black; padding: 5px; display: inline-block;"><p style="margin: 0; text-align: center;">RESOLUTION</p><p style="margin: 0; text-align: center;">{KNOB INCR}</p><div style="display: flex; justify-content: space-around; margin: 5px 0;">◀▶</div></div>	<ul style="list-style-type: none">• Rotary knob: Increments or decrements the output level.• RESOLUTION key: Selects the resolution digits when the output level is set using the rotary knob.• KNOB INCR key: Turns the output level resolution that can be incremented or decremented by the rotary knob into an increment step value. Press [SHIFT], then [>].
8	<p style="text-align: center;">OUTPUT</p> <div style="border: 1px solid black; padding: 5px; display: inline-block;"><p style="margin: 0; text-align: center;">INCR</p><p style="margin: 0; text-align: center;">{NORMAL}</p><div style="display: flex; justify-content: center; margin: 5px 0;">▲</div><p style="margin: 0; text-align: center;">{CONTINUOUS}</p><div style="display: flex; justify-content: center; margin: 5px 0;">▼</div></div>	<ul style="list-style-type: none">• [^] and [v] keys: Used to increment or decrement the output level in units of the output level increment step values set by [INCR SET].• NORMAL key: Sets the output level to normal mode. Press [SHIFT], then INCR [^].• CONTINUOUS key: Sets the output level to continuous mode. Press [SHIFT], then INCR [v].
9	<div style="border: 1px solid black; padding: 5px; display: inline-block;"><p style="margin: 0; text-align: center;">{RPP RESET}</p><p style="margin: 0; text-align: center;">RF OFF/ON</p><div style="width: 20px; height: 10px; margin: 5px auto; border: 1px solid black;"></div></div>	<ul style="list-style-type: none">• RF OFF/ON key: Used to switch the output signal ON/OFF. The signal is alternately switched ON/OFF each time the key is pressed.• When OFF, "OFF" is displayed on the OUTPUT display.• RPP RESET key: When the reverse power protection circuit operates due to the reverse power input, pressing this key release RPP operation and returns to the normal status. Press [SHIFT], then [RF OFF/ON].





The characters in {} are indicated in blue (the key corresponding to the shift key).

(Continued)

No.	Related panel indication	Equipment explanation																								
10	RF OUTPUT  50Ω	<ul style="list-style-type: none">• RF OUTPUT; Connector to output 0.1 to 1040 MHz (MG3631A) or 0.1 to 2080 MHz (MG3632A) with -143 to +13 dBm.																								
11	<p style="text-align: center;">DATA ENTRY</p> <table border="1" style="margin-left: auto; margin-right: auto;"><tr><td style="border: 1px solid black; padding: 2px;">7</td><td style="border: 1px solid black; padding: 2px;">8</td><td style="border: 1px solid black; padding: 2px;">9</td><td style="border: 1px solid black; padding: 2px;">dB RECALL GHz/dBm</td></tr><tr><td style="border: 1px solid black; padding: 2px;">{F-OFS}</td><td style="border: 1px solid black; padding: 2px;">{L-OFS}</td><td style="border: 1px solid black; padding: 2px;">{ADRS}</td><td style="border: 1px solid black; padding: 2px;">STORE MHz/dBμ</td></tr><tr><td style="border: 1px solid black; padding: 2px;">4</td><td style="border: 1px solid black; padding: 2px;">5L</td><td style="border: 1px solid black; padding: 2px;">6</td><td style="border: 1px solid black; padding: 2px;">% SKIP kHz/mV</td></tr><tr><td style="border: 1px solid black; padding: 2px;">{BELL}</td><td style="border: 1px solid black; padding: 2px;">{DSPL}</td><td style="border: 1px solid black; padding: 2px;">{EMF}</td><td style="border: 1px solid black; padding: 2px;">CLEAR Hz/μV</td></tr><tr><td style="border: 1px solid black; padding: 2px;">1</td><td style="border: 1px solid black; padding: 2px;">2</td><td style="border: 1px solid black; padding: 2px;">3</td><td></td></tr><tr><td style="border: 1px solid black; padding: 2px;">{SPECIAL}</td><td style="border: 1px solid black; padding: 2px;">0</td><td style="border: 1px solid black; padding: 2px;">.</td><td style="border: 1px solid black; padding: 2px;">+/-</td></tr></table>	7	8	9	dB RECALL GHz/dBm	{F-OFS}	{L-OFS}	{ADRS}	STORE MHz/dBμ	4	5L	6	% SKIP kHz/mV	{BELL}	{DSPL}	{EMF}	CLEAR Hz/μV	1	2	3		{SPECIAL}	0	.	+/-	<ul style="list-style-type: none">• 0 to 9, ., +/-: Used for setting the numeric data.• GHz/dBm MHz/dBμ kHz/mV Hz/μV Set appropriate units after data is set.• SPECIAL key: Used to use the special functions of the MG3631A/MG3632A, press [SHIFT], then [0]. And input 3-digit numeric code (special function code).• BELL key: Sets bell sound ON or OFF that signals key operation or error occurrence. The bell sound is alternately turned ON or OFF each time [1] is pressed after pressing [SHIFT].• DSPL key: Sets all displays ON or OFF on the panel except POWER. The displays are alternately turned ON or OFF each time [2] is pressed after pressing [SHIFT].• EMF key: Used to switch the output level display between terminal voltage display and open-circuit voltage display. The display mode is alternately switched between terminal and open-circuit display each time [3] is pressed after pressing [SHIFT].• F-OFS key: Used to set the frequency offset. Press [SHIFT], then [4].• L-OFS key: Sets the level offset. Press [SHIFT], then [5].• ADRS key: Sets or reads the GP-IB address. Press [SHIFT], then [6].
7	8	9	dB RECALL GHz/dBm																							
{F-OFS}	{L-OFS}	{ADRS}	STORE MHz/dBμ																							
4	5L	6	% SKIP kHz/mV																							
{BELL}	{DSPL}	{EMF}	CLEAR Hz/μV																							
1	2	3																								
{SPECIAL}	0	.	+/-																							
12	<table border="1" style="margin-left: auto; margin-right: auto;"><tr><td style="border: 1px solid black; padding: 2px;">BS</td></tr></table>	BS	<ul style="list-style-type: none">• BS key: Backspace key to correct erroneous data key input.																							
BS																										

The characters in {} are indicated in blue (the key corresponding to the shift key).

(Continued)

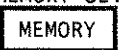
No.	Related panel indication	Equipment explanation
13	<p style="text-align: center;">SHIFT </p>	<ul style="list-style-type: none">● SHIFT key: Used to execute the function shown in blue letters among the front panel keys, press this key and then the blue-letter key of the function to be operated.
14	<p style="text-align: center;"></p>	<ul style="list-style-type: none">● INCR SET key: Header key to set the increment step value when increment operation is performed with the INCREMENT [^] [v]. This key is only valid in the carrier frequency, AF frequency, or output level setting mode.
15	<p style="text-align: center;">{AF(OPT)}   {MOD MIX}  {MEMORY SET} </p>	<ul style="list-style-type: none">● FREQ key: Header key to set the carrier frequency. Pressing this key once places the unit in the frequency setting mode and the carrier frequency can be set using the data key. Also, the INCREMENT [^] [v] and rotary knob in Nos. 16 and 17 are used for setting the carrier frequency.● LEVEL key: Header key to set the output level. Pressing this key once places the unit in the output level setting mode and the output level can be set using the data key.● MOD key: Header key to set the AM modulation factor or FM frequency deviation. Pressing this key once places the unit in the modulation factor/frequency deviation setting mode and the modulation factor or frequency deviation can be set using the data key.● MEMORY key: Header key to set memory. Pressing this key once places the unit in the memory setting mode and memory can be set using the data keys. Also, the increment step key and rotary knob in Nos. 16 and 17 are used for setting memory addresses.

The characters in {} are indicated in blue (the key corresponding to the shift key).

(Continued)

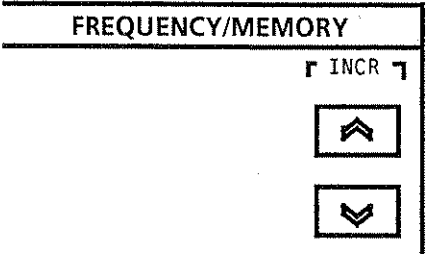
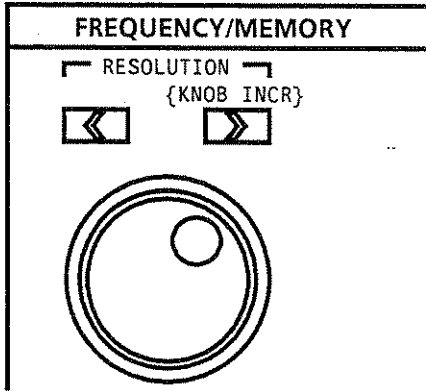
No.	Related panel indication	Equipment explanation
15	(Continued from the preceding page)	<ul style="list-style-type: none"> • AF key: Header key to set the AF frequency. Pressing the [FREQ] after pressing the [SHIFT] places the unit in the AF frequency setting mode and AF frequency can be set using the data keys. Also, the INCREMENT [^] [v] and rotary knob in Nos. 16 and 17 are used for setting the AF frequency. This key is valid only when the AF oscillator is equipped. • MOD MIX key: Header key to set the AM modulation factor or frequency deviation of the MIX modulating signal. Pressing the [MOD] after pressing the [SHIFT] places the unit in the MIX signal modulation factor/frequency deviation setting mode and the MIX signal modulation factor or frequency deviation can be set using the data keys. • MEMORY SET key: Header key to set memory for store, skip or clear. Pressing the [MEMORY] after pressing the [SHIFT] places the unit in the memory setting.
16		<ul style="list-style-type: none"> • [^] and [v] keys: Used to increment or decrement the frequency or AF frequency in units of frequency or AF frequency increment step values set by the [INCR SET]. In memory recall mode, this key is used to increment or decrement the memory address.
17		<ul style="list-style-type: none"> • Rotary knob: Increments or decrements the frequency or AF frequency memory address. • RESOLUTION key: Selects the resolution digits when the frequency or AF frequency is set using the rotary knob. • KNOB INCR key: Turns the resolution of the frequency or AF frequency when increment operation is performed with the rotary knob into an increment step value. Press [SHIFT], then [>].



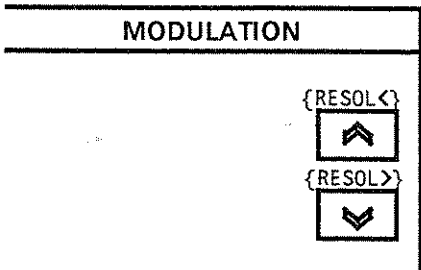
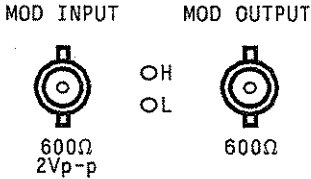
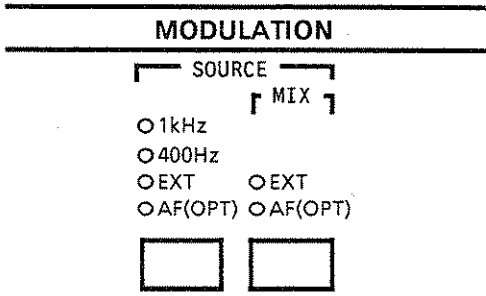
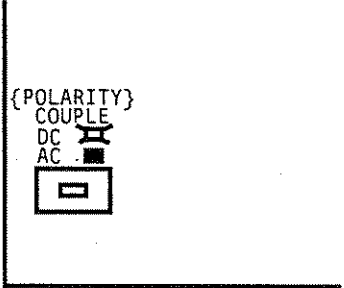

The characters in {} are indicated in blue (the key corresponding to the shift key).

(Continued)

No.	Related panel indication	Equipment explanation
18	 <p>The diagram shows a rectangular display area with the word "MODULATION" centered at the top. Below the display, there are two keys. The top key is labeled "{RESOL<}" and has an upward-pointing arrow. The bottom key is labeled "{RESOL>}" and has a downward-pointing arrow.</p>	<ul style="list-style-type: none">• [^] and [v] keys: Used to increment or decrement the modulation factor or frequency deviation.• RESOL [<] key, [>] key: Selects the digit to be incremented or decremented by the [^] and [v]. Pressing [^] or [v] after pressing [SHIFT], the MODULATION display flickers digit by digit and the resolution digit moves sequentially.
19	 <p>The diagram shows two circular connectors. The left one is labeled "MOD INPUT" and has "600Ω" and "2Vp-p" below it. The right one is labeled "MOD OUTPUT" and has "600Ω" below it. Between the two connectors are two small circles labeled "OH" and "OL".</p>	<ul style="list-style-type: none">• MOD INPUT: External modulation connector.• H, L LEDs: Indicates to adjust an external modulation signal to the appropriate level.• MOD OUTPUT: Output connector for monitoring the modulation signal.
20	 <p>The diagram shows a rectangular display area with "MODULATION" centered at the top. Below the display, there are two keys. The left key is labeled "SOURCE" and has a list of options: "1kHz", "400Hz", "EXT", and "AF(OPT)". The right key is labeled "MIX" and has a list of options: "EXT" and "AF(OPT)". Below the keys are two empty rectangular boxes.</p>	<p>Modulating signal select key: Selects the MAIN modulation signal. Every time this key is pressed when modulation is ON, signal is switched in the order of 1 kHz, 400 Hz, EXT, AF and 1 kHz.</p> <p>MIX key: Selects the MIX modulation signal. Every time this key is pressed when modulation is ON, signal is switched in the order of EXT, AF, OFF and EXT. (If the AF oscillator (Option 04) is not installed, AF is omitted.)</p>
21	 <p>The diagram shows a rectangular display area. Below the display, there are two keys. The left key is labeled "{POLARITY}" and has "DC" and "AC" below it. The right key is labeled "COUPLE" and has "DC" and "AC" below it. Below the keys are two small squares, one white and one black.</p>	<ul style="list-style-type: none">• COUPLE key: Switches external modulation input to AC or DC coupling. Switched to DC coupling when the key LED lights; switched to AC coupling when the key LED goes off.• POLARITY key: Switches the polarity of external modulation input. Press [SHIFT], then [COUPLE]. When the polarity is inverted, "INVS" is lit on the MODULATION display.

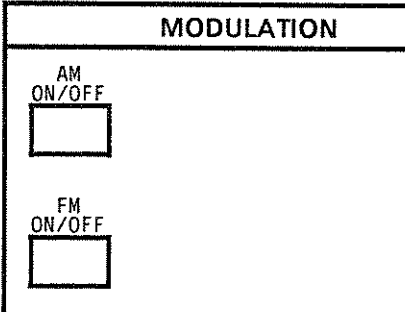
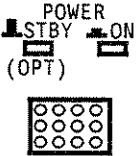



The characters in {} are indicated in blue (the key corresponding to the shift key).

(Continued)

No.	Related panel indication	Equipment explanation
22		<ul style="list-style-type: none"> ● AM ON/OFF key: Turns AM modulation ON. AM modulation is turned OFF when the key is pressed while AM is ON. ● FM ON/OFF key: Turns FM modulation ON. FM modulation is turned OFF when the key is pressed while FM is ON.
23		<ul style="list-style-type: none"> ● POWER switch: When this switch is set to the ON position, power is supplied to the MG3631A/MG3632A. When this switch is set to the STBY position, power is supplied only to the high-stability reference crystal oscillator (optional). STBY does not work when the LINE switch on the rear panel is OFF.
24		<ul style="list-style-type: none"> ● LOCAL key: Shifts the REMOTE status to the LOCAL status when the MG3631A/MG3632A is remotely controlled via GP-IB.
25		<ul style="list-style-type: none"> ● STATUS key: When this key is pressed while the [STATUS] LED is on, the FREQUENCY display displays an error message while the key is held down. ● INITIAL key: Initializes the MG3631A/MG3632A. Press [SHIFT], then [STATUS]. The initialization status can be changed by the special function.
26		<ul style="list-style-type: none"> ● AUX: Power supply connector for the MA1610A Pulse Modulator.
27		<ul style="list-style-type: none"> ● REMOTE CONTROLLER: Connector for connecting the exclusive Remote Controller (sold separately) to control the MG3631A/MG3632A.



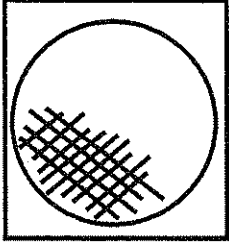
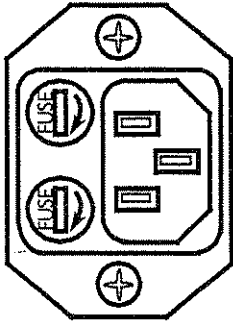

The characters in {} are indicated in blue (the key corresponding to the shift key).

(Continued)

No.	Related panel indication	Equipment explanation
28	<p data-bbox="565 323 699 380">-LINE OFF ON</p> 	<ul style="list-style-type: none">• ~ LINE: Main power supply switch. Normally this switch must be left ON. (Options 01 to 03)
29	<p data-bbox="607 520 659 562">FREQ ADJ</p> 	<ul style="list-style-type: none">• FREQ ADJ: Adjustment hole for fine tuning the frequency of the high-stability reference crystal oscillator (options 01 to 03).
30	<p data-bbox="591 667 672 709">REF OUTPUT</p> 	<ul style="list-style-type: none">• REF OUT: Output connector for the high-stability reference crystal oscillator (options 01 to 03). This connector is jointed to the REF INPUT connector located below it by a U-link cable.
31		<ul style="list-style-type: none">• Fan for discharging heat generated from inside the MG3631A/MG3632A to the outside. An open space of at least 10 cm must be provided around the fan.
32		AC power inlet for plugging the supplied power cord. The fuse holder contains two xxx/xxxx A fuses.
33		This terminal must be grounded to earth to prevent electric shock. This is called the Frame Ground (FG) terminal.

The characters in {} are indicated in blue (the key corresponding to the shift key).

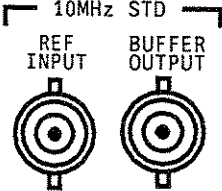
(Continued)

No.	Related panel indication	Equipment explanation
34	<p data-bbox="418 317 483 338">GP-IB</p>  <p data-bbox="298 478 613 520">SH0 AH1 TO L4 TE0 LE0 SR0 RL1 PPO DC1 DT0 C0 E2</p>	<ul style="list-style-type: none">● GP-IB: When using a GP-IB remote control, connect the GP-IB interface bus to this connector. When in the remote mode, the REMOTE LED on the front panel lights.
35		<ul style="list-style-type: none">● FREQ ADJ: Adjustment hole for fine tuning the frequency of the internal reference oscillator (standard type).
36		<ul style="list-style-type: none">● REF INPUT: A reference signal input connector. Inputting a 10 MHz, TTL-level external signal places the unit automatically in the external reference oscillator mode.● BUFFER OUTPUT: Used to output the external reference signal input to REF INPUT or the internal reference signal at the TTL level. If the BUFFER output is not used, leave the BNC cover on.
37		<ul style="list-style-type: none">● DC FM ADJ: Adjustment hole used to adjust the carrier frequency in the DC FM mode.

The characters in {} are indicated in blue (the key corresponding to the shift key).

3.2 Power On

This paragraph describes the power switches on the front and rear panels and their relationship to each other.

- ~LINE ON/OFF on the rear panel
- POWER ON/STBY on the front panel

3.2.1 ~LINE ON/OFF on rear panel

Before turning on the power to the MG3631A/MG3632A, ground the instrument as described in paragraph 2.2.1, then plug the power cord into an AC inlet.

WARNING: *If the power is turned on without the frame grounded, there is a danger of electric shock. When a 3-pole (grounded type 2-pole) AC outlet is not available, always connect the rear panel frame ground (FG) terminal to earth potential.*

CAUTION: *If the AC line voltage is incorrect, the instrument may be damaged. Before turning on the power to the MG3631A/MG3632A, check that the AC line voltage is $\pm 10\%$ to $\pm 15\%$.*

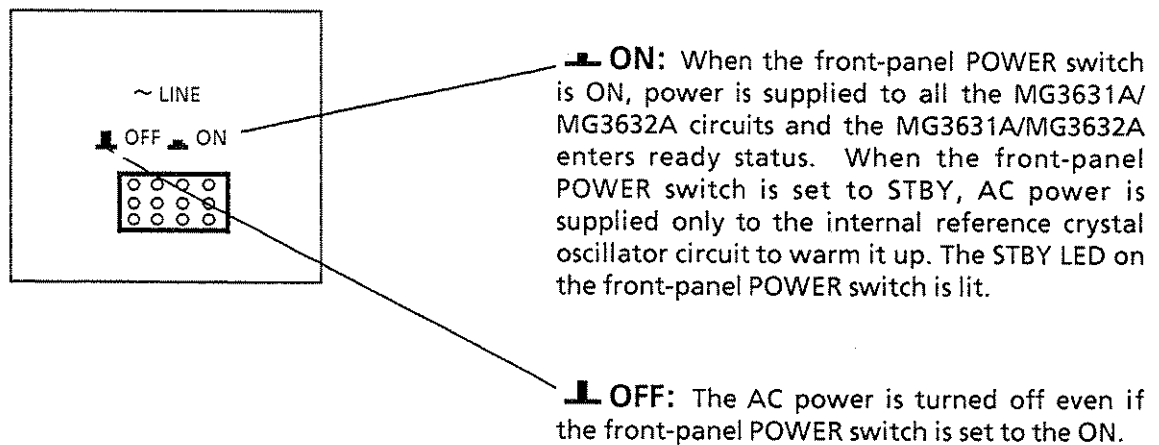

Fig. 3-1 Rear-Panel LINE Switch (Mounted Only with Option 01 to 03)

3.2.2 POWER ON/STBY on front panel

The POWER switch on the front panel is used when the ~LINE switch on the rear panels set to ON (Only when option 01 to 03 mounted).

Note: Succeeding pages describe the status with the rear-panel ~LINE switch set to ON unless otherwise specified except when all the MG3631A/MG3632A circuits must be turned off.

⏏ STBY :

At STBY when the rear panel ~LINE switch is ON, power is supplied only to the reference crystal oscillator circuit and the STBY LED is lit.

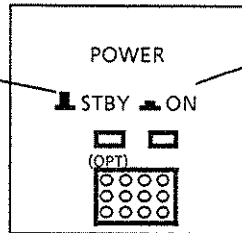

⏏ ON : When the rear-panel ~LINE switch is ON, LED is lit and power is supplied to all the MG3631A/MG3632A circuits and the MG3631A/MG3632A enters the ready state.

Fig. 3-2 Front-Panel POWER Switch

3.3 Preparation Before Operation

This paragraph details the necessary preparations for operation of the MG3631A/MG3632A.

- Using the internal reference oscillator
- Using an external reference oscillator

3.3.1 Using internal reference oscillator

The reference oscillator must be warmed-up before using the MG3631A/MG3632A.

Step	Procedure
1	Ground the rear-panel FG terminal when the power cord is 2-pole (no ground) type.
2	Before plugging the power cord into an AC outlet, check that the AC line voltage is correct.
3	After checking that the rear-panel ~LINE switch is set to OFF and the front-panel POWER switch is set to STBY, plug the power cord into the AC outlet.
4	Set the rear-panel ~LINE switch to ON. (The internal reference oscillator circuit will be energized and the oscillator will be warmed-up. Always warm-up the oscillator properly for stable measurement.)
5	Set the front-panel POWER switch to ON.

Note: When the internal reference oscillator is used, check that the rear-panel REF OUTPUT and REF INPUT connectors are connected with the U-link.

3.3.2 Using external reference oscillator

An external reference oscillator can be used instead of the internal device. To use an external oscillator, make the initial POWER ON settings as described previously, then follow the procedure below.

Step	Procedure
1	Check that the external reference oscillator frequency output is $10 \text{ MHz} \pm 100 \text{ Hz}$.
2	Check that the output from the external reference oscillator is at the TTL level.
3	Remove the U link and connect the external reference oscillator output to the REF INPUT connector.

Note: Be sure to put the BNC cover to the ,BUFFER OUTPUT (BNC) connector whn the 10 MHz buffered output is not used.

3.4 Reproducing Set Parameters

Since the MG3631A/MG3632A automatically stores in memory the set conditions (function parameters) immediately before the unit is powered off, these set conditions can be reproduced immediately after powering on the unit.

3.5 Initialization

To initialize the MG3631A/MG3632A, press [SHIFT], then [STATUS].

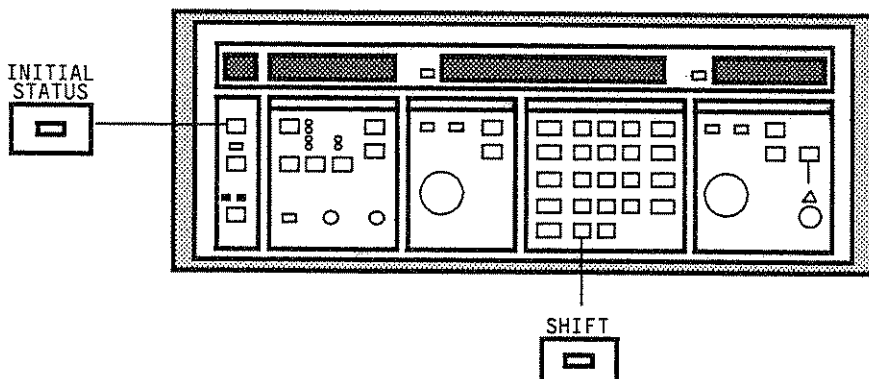

When initialized, the contents of the initial memory are read and set to the panel. The following describes the initialization status of the MG3631A/MG3632A at factory-shipment.

Carrier frequency/increment step value	1040 MHz/1 MHz	
Output level/increment step value	-30 dBm/1 dB	
AM modulation/FM modulation	OFF	Parameters which are set when modulation function is turned ON.
AM modulation factor/FM frequency deviation	30%/3.5 kHz	
Modulation signal source	1 kHz	
External modulation input	Non-inverted, AC coupling	

The contents of the initial memory can be modified using the special function. (For details, refer to paragraph 4.5.2 (3).)

Note: To reset the MG3631A/MG3632A to its factory-shipment conditions, press [SHIFT], then [0] four times. Thus complete initialization. Note that when completely initialized, the memory contents stored may all be lost. For details on complete initialization, refer to paragraph 4.5.2 (2).

3.6 Basic Operation

This paragraph explains the basic operation method for the following setting items:

- Carrier frequency
- Output level
- Modulation
- Memory

3.6.1 Setting carrier frequency

Press [FREQ], numeric data keys, and unit key in this order to set carrier frequency. There are four data entry methods depending on the frequency unit keys selection ([GHz/dBm], [MHz/dB μ], [kHz/mV], and [Hz/ μ V]).

Example: Set carrier frequency

455 kHz → [FREQ] [4] [5] [5] [kHz/mV]
10.7 MHz → [FREQ] [1] [0] [.] [7] [MHz/dB μ]

When setting frequencies repeatedly, it is not necessary to press the [FREQ] each time.

3.6.2 Setting output level

Press [LEVEL], numeric data keys, and unit key in this order to set output level. There are four data entry methods depending on the output level unit key selection ([GHz/dBm], [MHz/dB μ], [kHz/mV], and [Hz/ μ V]) according to the unit system and the output level setting value.

Example: Set output level

+7 dBm → [LEVEL] [7] [GHz/dBm]
-10 dB μ → [LEVEL] [+/-] [1] [0] [MHz/dB μ]

When setting output levels repeatedly, it is not necessary to press the [LEVEL] each time.

3.6.3 Setting modulation

To set modulation, follow the procedure described below:

- ① Turn modulation ON. Press [AM ON/OFF] or [FM ON/OFF].
- ② Select the modulation signal source Select one from 1 kHz, 400 Hz, EXT, and AF using the appropriate key in the SOURCE section.
- ③ Set AM modulation factor or FM frequency deviation Set [MOD], numeric data keys, and unit key in this order to set AM modulation factor or FM frequency deviation.

Example: Apply FM modulation with a 3 kHz frequency deviation and a 400 Hz modulation frequency.

1. [FM ON/OFF] Turn FM modulation ON.
 2. SOURCE section key Repeatedly press the key until the 400 Hz LED lights.
 3. [MOD][3][kHz/mV] Set the FM frequency deviation to 3 kHz.
-

3.6.4 Storing in and recalling from memory

(1) Storing in memory

Press [SHIFT], [MEMORY] (MEMORY SET key), numeric data keys (memory address), and [MHz/dB μ] (STORE keys) in this order to store the current panel settings in memory.

Example: Set a 875 MHz carrier frequency and a 12 dB μ output level, then stores the settings in memory address 46.

1. [FREQ][8][7][5][MHz/dB μ] Set the carrier frequency to 875 MHz.
 2. [LEVEL][1][2][MHz/dB μ] Set the output level to 12 dB μ .
 3. [SHIFT][MEMORY][4][6][MHz/dB μ] Store the settings in memory address 46.
-

(2) Recalling from memory

To recall the contents of memory and set them to the panel, press [MEMORY], numeric data keys (memory address), and [GHz/dBm] (RECALL keys) in this order.

Example: Recall memory contents at address 46.

- [MEMORY][4][6][GHz/dBm] Recall memory contents at address 46.
-

When recalling memory contents repeatedly, it is not necessary to press the [MEMORY] each time.

SECTION 4 OPERATION INSTRUCTIONS

The MG3631A/MG3632A Synthesized Signal Generator can be operated directly or by GP-IB remote control. The operation and function of hand controls on the front and rear panels are described in this section. For a description of the GP-IB remote system, refer to the Section 6.

4.1 Setting Carrier Frequency

The following can be used to set the carrier frequency (hereafter called simply the frequency).

- Data keys
- Increment step key
- Rotary knob

In addition, there are special display and setting modes as follows:

- Relative frequency display mode
- Frequency offset setting mode

Frequency setting range	0 Hz to 1040 MHz (MG3631A)
	0 Hz to 2080 MHz (MG3632A)
Minimum frequency setting resolution .	10 Hz
Initially set frequency	1040 MHz

4.1.1 Setting frequency using data keys

Set [FREQ], numeric data keys, and unit keys in this order to set frequency. There are four data entry methods depending on the frequency unit key selection ([GHz/dBm], [MHz/dB μ], [kHz/mV], and [Hz/ μ V]).

Example: Setting carrier frequency

455 kHz	→	[FREQ] [4] [5] [5] [kHz/mV]
10.7 MHz	→	[FREQ] [1] [0] [.] [7] [MHz/dB μ]
960 MHz	→	[FREQ] [.] [9] [6] [GHz/dBm]

Pressing the [FREQ] placed the unit in the frequency setting mode and kept in this mode unless some other FUNCTION key is pressed. Therefore, frequencies can be sequentially set by only pressing the numeric data keys and unit keys repeatedly.

4.1.3 Setting frequency using rotary knob

Frequencies can be incremented or decremented in any digit by turning the rotary knob in the FREQUENCY/MEMORY zone. The variable digits can be selected from seven digits from 10 Hz to 10 MHz by pressing RESOLUTION [<] or [>] in the FREQUENCY/MEMORY zone. The initial value for this setting is 10 Hz.

Example: After setting the frequency to 363.2 MHz, change the frequency with a 100 Hz resolution.

- | | |
|--|--|
| 1. [FREQ] | Set the unit in frequency setting mode. |
| 2. [3] [6] [3] [.] [2] [MHz/dBμ] | Set the frequency to 363.2 MHz. |
| 3. RESOLUTION [<] OR [>] | Press RESOLUTION [<] or [>] until the 100 Hz's digit on the FREQUENCY display begins to blink. |
| 4. Turn the rotary knob clockwise or counterclockwise. | The frequency is changed in 100 Hz steps. |

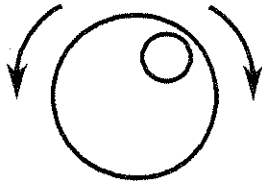

When the RESOLUTION [<] or [>] key is pressed, the display of the resolution digit left or right to the currently set resolution digit blinks one time and the resolution digit moves. Then, when the key is pressed again or held down for about 1 second or more, the blinking figure on display moves to the left or right one digit at a time and the resolution digit moves sequentially.

Key operation

RESOLUTION [<]

Hold down the key until the resolution digit display is blinked on the digit of the desired resolution.

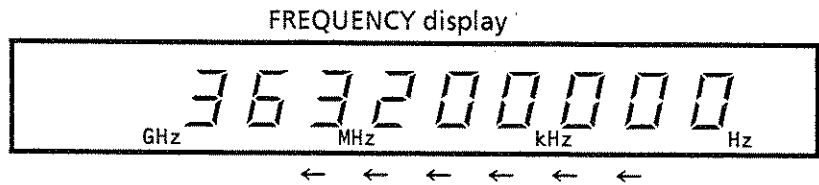

RESOLUTION [>]

Hold down the key until the resolution digit display is blinked on the digit of the desired resolution.

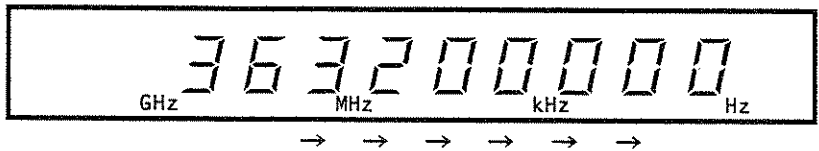

By pressing RESOLUTION [>] (KNOB INCR key) after pressing [SHIFT], the frequency can be incremented or decremented in units of the increment step value described in paragraph 4.1.2 using the rotary knob.

Pressing RESOLUTION [>] (KNOB INCR key) again after [SHIFT] or pressing RESOLUTION [<] or [>], restores to the previously set resolution digit and normal rotary knob operation is possible.

4.1.4 Displaying relative frequency

(1) Setting relative frequency display mode

When [RELATIVE] beside the side of the FREQUENCY display is pressed while an output frequency is shown on the FREQUENCY display, the unit is placed in the relative frequency display mode and the display value is set to 0 Hz. This is the relative frequency display reference value 0 Hz.

When in the relative frequency display mode, the [RELATIVE] LED lights and the plus or minus sign lights at the left most digit of the FREQUENCY display, to indicate the relative frequency display mode.

The actual output frequency in the relative frequency display mode can be obtained using the following equation.

$$\text{Actual output frequency} = \boxed{\text{Frequency when [RELATIVE] pressed}} + \boxed{\text{Current relative value displayed}}$$

The unit can be placed in the relative frequency display mode at any time as long as some frequency is being displayed on the FREQUENCY display.

(2) Checking the actual output frequency in the relative frequency display mode

When an actual output frequency check is required in the relative frequency display mode, continue to press the [RELATIVE] (CUR DSPL key) after pressing [SHIFT]. The actual output frequency is displayed while the key is held down and is returned to the relative frequency display when released.

(3) Exiting relative frequency display mode

Pres [RELATIVE] again to exit the relative frequency display mode. The output frequency at this time is the frequency indicated immediately before the relative frequency display mode is exited.

4.1.5 Frequency offset setting mode

Frequency offset setting refers to a function that offsets the set and displayed values against the actual output frequency by a value that you set as an offset value.

Press [SHIFT], [4] (F-OFS key), numeric data keys, and unit keys in this order to set an offset value. When an offset value is set, the set and displayed values are offset against the actual output frequency by that offset value. Offset values can be set in the range of -1040 MHz to 1040 MHz for the MG3631A or -2080 MHz to 2080 MHz for the MG3632A.

Press [SHIFT], [4] (F-OFS key), [0], and [Hz/μV] in this order to clear frequency offset settings. The offset value is reduced to 0 Hz and the set and displayed values match the actual output frequency.

When the frequency offset is set (i.e., offset value is not 0 Hz), "F" is displayed at the right most digit of the FREQUENCY display to indicate the frequency offset is set.

The actual output frequency when the frequency offset is set can be obtained using the following equation.

$$\text{Actual output frequency} = \boxed{\text{Frequency set from panel or via GP-IB and frequency read from display or via GP-IB}} - \boxed{\text{Frequency offset value}}$$

When an actual output frequency check is required, continue to press [RELATIVE] (CUR DSPL key) after pressing [SHIFT]. The actual output frequency is displayed while the key is held down.

Example: Set the frequency offset value to 10.7 MHz, set a frequency to 363.2 MHz from the panel, and output 363.2 MHz - 10.7 MHz = 352.5 MHz via the output connector.

1. [SHIFT] [4] [1] [0] [.] [7] [MHz/dBμ] Set the frequency offset value to 10.7 MHz.
2. [FREQ] [3] [6] [3] [.] [2] [MHz/dBμ] Set the frequency to 363.2 MHz.
Although 363.2 MHz is displayed at this time, the actual output frequency is 352.5 MHz.

Frequency display



When the offset value check is required, continue to press [4] (F-OFS key) for 0.5 seconds or more after pressing [SHIFT]. The display is returned to the previous display when the [4] (F-OFS key) is released.

Key operation

[SHIFT] [4]
↑
Hold down.

Frequency display



← Offset value is displayed.

Note: If the frequency is set to any value below 100 kHz, the [STATUS] LED lights. At this time, pressing [STATUS] displays the following error message on the display while the key is held down and indicate that the output signal characteristics are not guaranteed.

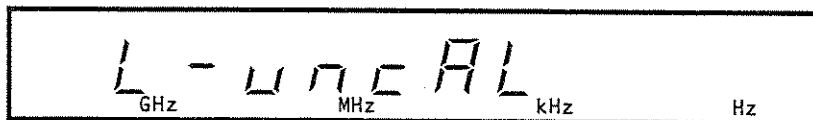

If an erroneous frequency is set, [STATUS] LED lights and displays the previous frequency. At this time, pressing [STATUS] displays the following error message on the display while the key is held down.

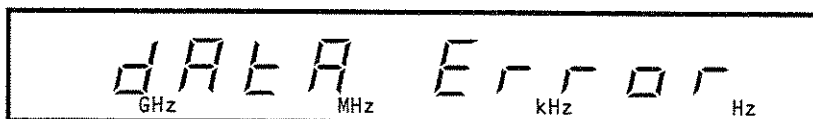

... Attempted to set frequency outside the setting range.

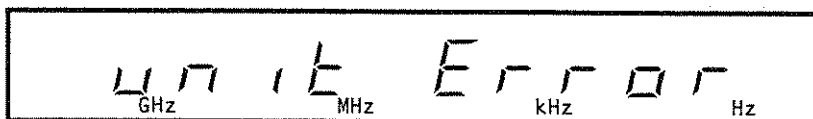

... Any key other than the unit key was pressed during or after numeric data entry.

4.2 Setting Output Level

Following can be used to set the output level:

- Data keys
- Increment step key
- Rotary knob

In addition, there are special display and setting modes as follows:

- Relative level display mode
- Output level offset setting mode

Output level setting range -143 dBm to +13 dBm

Minimum resolution of output level setting 0.1 dB

Initial output level -30 dBm

Output levels can be displayed in units of dB μ and V, in addition to dBm. The following shows the relationship between these units of output levels:

$$X (\text{dB}\mu \text{ EMF}) = A (\text{dBm}) + 113 (\text{dB})$$

$$X (\text{dB}\mu) = A (\text{dBm}) + 107 (\text{dB})$$

$$X (\text{V EMF}) = 10 \{A (\text{dBm}) - 7\} / 20$$

$$X (\text{V}) = 10 \{A (\text{dBm}) - 13\} / 20$$

The minimum resolution of output level setting is 0.1 dB regardless of the unit of measurement used. For setting output level in units of voltage, therefore, the resolution varies depending on the range of that output level as follows:

Unit	Output level value	Minimum resolution of display	Minimum resolution of output level
dBm	13.0 to -143.0 dBm	0.1 dB	0.1 dB
dB μ	126.0 to -30.0 dB μ (120.0 to -36.0 dB μ)	0.1 dB	0.1 dB
V	2.00 to 1.00 V (1.00)	0.01 V	0.1 dB
mV	999 to 100 mV 99.9 to 10.0 mV 9.99 to 1.00 mV	1 mV 0.1 mV 0.01 mV	0.1 dB 0.1 dB 0.1 dB
μ V	999 to 100 μ V 99.9 to 10.0 μ V 9.99 to 1.00 μ V 0.999 to 0.032 μ V (0.016)	1 μ V 0.1 μ V 0.01 μ V 0.001 μ V	0.1 dB 0.1 dB 0.1 dB 0.1 dB

Figures in () are for display in terminal voltage

4.2.1 Displaying open-circuit voltage and terminal voltage

The MG3631A/MG3632A displays the output level in the following units of measurement as shown by the output level setting range in the preceding page.

- Output level display in the unit of power dBm
- Output level display in the unit of voltage . . . dB μ , V, mV, μ V
- Relative output level display dB

Furthermore, when displayed in units of voltage, you can select between display in open-circuit voltage or display in terminal voltage.

Display in open-circuit voltage and in terminal voltage can be alternately switched by pressing [3] after pressing [SHIFT]. When displayed in open-circuit voltage, "EMF" is lit on the OUTPUT LEVEL display.

The MG3631A/MG3632A is set for open-circuit voltage display in initial setting.

4.2.2 Output level setting using data keys

Press [EVEL], numeric data keys, and unit keys in this order to set output level. There are four data key entry methods depending on the output level unit key selection ([GHz/dBm], [MHz/dB μ], [kHz/mV], and [Hz/ μ V]) according to the unit format and the output levels setting value.

Example: Set output level

- + dBm → [LEVEL] [7] [GHz/dBm]
- 10 dB μ → [LEVEL] [+/-] [1] [0] [GHz/dB μ]

Pressing [LEVEL] once, sets the unit in the output level setting mode and kept in this mode unless any other FUNCTION key is pressed. Therefore, output levels can be sequentially set only by pressing the numeric data keys and unit keys repeatedly.

When entering the output level in units of voltage (in units of V), select the unit key (mV or μ V) so that the input data is equal to or less than three digits. However, if the input data is less than 1 and input the data from the decimal point, 0's in the digits above the decimal place are not included in the count of digits. Also note that if the figure in the first place of the numeric data is 1, data can be entered in up to four digits with the last digit discarded, however.

Display on the OUTPUT LEVEL display immediately after data entry is in the range of 0.016 to 999 μ V, 1.00 to 999 mV, or 1.00 to 2.00 V regardless of which unit key you pressed during input.

If the unit key is pressed without entering numeric data, only the "unit" display on the display changes with the actual output level left intact. However, pressing [kHz/mV] or [Hz/ μ V], the appropriate unit is displayed after automatically selection it from μ V, mV, and V.

4.2.3 Output level setting using increment step key

The actual level can be incremented or decremented at equal intervals by operating the INCR [^] or [v] in the OUTPUT zone.

Pressing [LEVEL], [INCR SET], numeric data keys and [GHz/dBm] (dB keys) in this order to set the increment step value. If the unit is already placed in the output level setting mode with [LEVEL], it is not necessary to press [LEVEL] again.

Increment step value setting range 0.1 dB to 156 dB

Initial increment step value 1 dB

Example: After setting the output level to 0 dBm, decrement it to -60 dBm in 6 dB steps.

1. [LEVEL] Set the unit in the output level setting mode.
2. [0] [GHz/dBm] Set the output level to 0 dBm.
3. [INCR SET] [6] [GHz/dBm] Set the increment step value to 6 dB.
4. Press [v] 10 times. The output level is decremented to -60 dBm in 6 dB steps

The INCR [^] and [v] increment or decrement the output level at intervals set as the increment step value each time the key is pressed. Also, the output level can be incremented or decremented continuously by holding down the key for about 1 second or more.

To confirm the increment step value, press the [INCR SET] and hold it down for 0.5 seconds or more.

Key operation

Frequency display

[INCR SET]



Hold down.

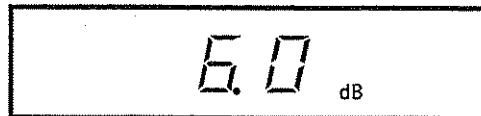

← Increment step value is displayed.

Even when the OUTPUT LEVEL display is in units of μ V, mV, or V, the increment step value can only be set in units of dB.

Example: After setting the output level to 10 mV, increment it to 1 V in 10 dB steps.

1. [LEVEL] Set the unit in the output level setting mode.
2. [1] [0] [kHz/mV] Set the output level to 10 mV.
3. [INCR SET] [1] [0] [GHz/dBm] Set the increment step value to 10 dB.
4. Press [^] 4 times. The output level is incremented to 1 V at a rate of $10^{(10 \text{ dB})/20} \approx 3.16$ times every time

10.0 mV
 ↓ 31.6 mV
 ↓ 100 mV
 ↓ 316 mV
 1.00 V

4.2.4 Output level setting using rotary knob

Output levels can be incremented or decremented in any digit by turning the rotary knob in the OUTPUT zone.

By pressing RESOLUTION [<] or [>] in the OUTPUT zone, variable digit can be selected from three values: 10 dB, 1 dB, and 0.1 dB. The initial value of variable digit is 0.1 dB.

Example: After setting the output level to 0 dBm, change the output level with a 1 dB resolution.

- | | |
|---|---|
| 1. [LEVEL] | Place the unit in the output level setting mode. |
| 2. [0] [GHz/dBm] | Set the output level to 0 dBm. |
| 3. RESOLUTION [<] or [>] | Press the RESOLUTION [<] or [>] until the 1 dB's digit on the OUTPUT LEVEL display begins to blink. |
| 4. Turn the rotary knob clockwise or counterclockwise | The output level is changed in 1 dB steps. |

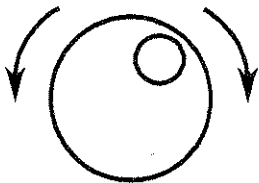

When the RESOLUTION [<] or [>] is pressed, the display of the resolution digit left or right to the currently set resolution digit blinks one time and the resolution digit moves. Then, when the key is pressed again or held down for about 1 second or more, the blinking figure on display moves to the left or right one digit at a time and the resolution digit moves sequentially.

Key operation
RESOLUTION [<] Hold down the key until the resolution digit display is blinked on the digit of the desired resolution.

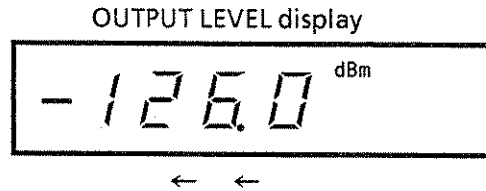

RESOLUTION [>] Hold down the key until the resolution digit display is blinked on the digit of the desired resolution.

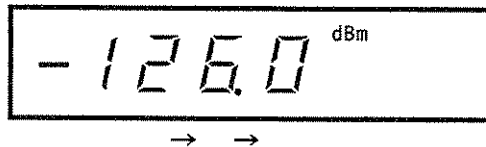

By pressing RESOLUTION [>] (KNOB INCR key) after pressing [SHIFT], the output level can be incremented or decremented in units of the increment step value described in paragraph 4.2.3 using the rotary knob.

Pressing RESOLUTION [>] (KNOB INCR key) again after [SHIFT] or pressing RESOLUTION [<] or [>] restore to the previously set resolution digit and normal rotary knob operation is possible.

4.2.5 Output level continuous variable mode

The MG3631A/MG3632A has two types of attenuators: a 0.1 dB-step ALC attenuator and a 5 dB-step mechanical attenuator. During normal mode, the MG3631A/MG3632A sets the output level in the range of +13 to -143 dBm with a 0.1 dB resolution by automatically switching over these two attenuators according to the set value of the output level.

The following figure shows the output level set values and each attenuator setting of the MG3631A/MG3632A.

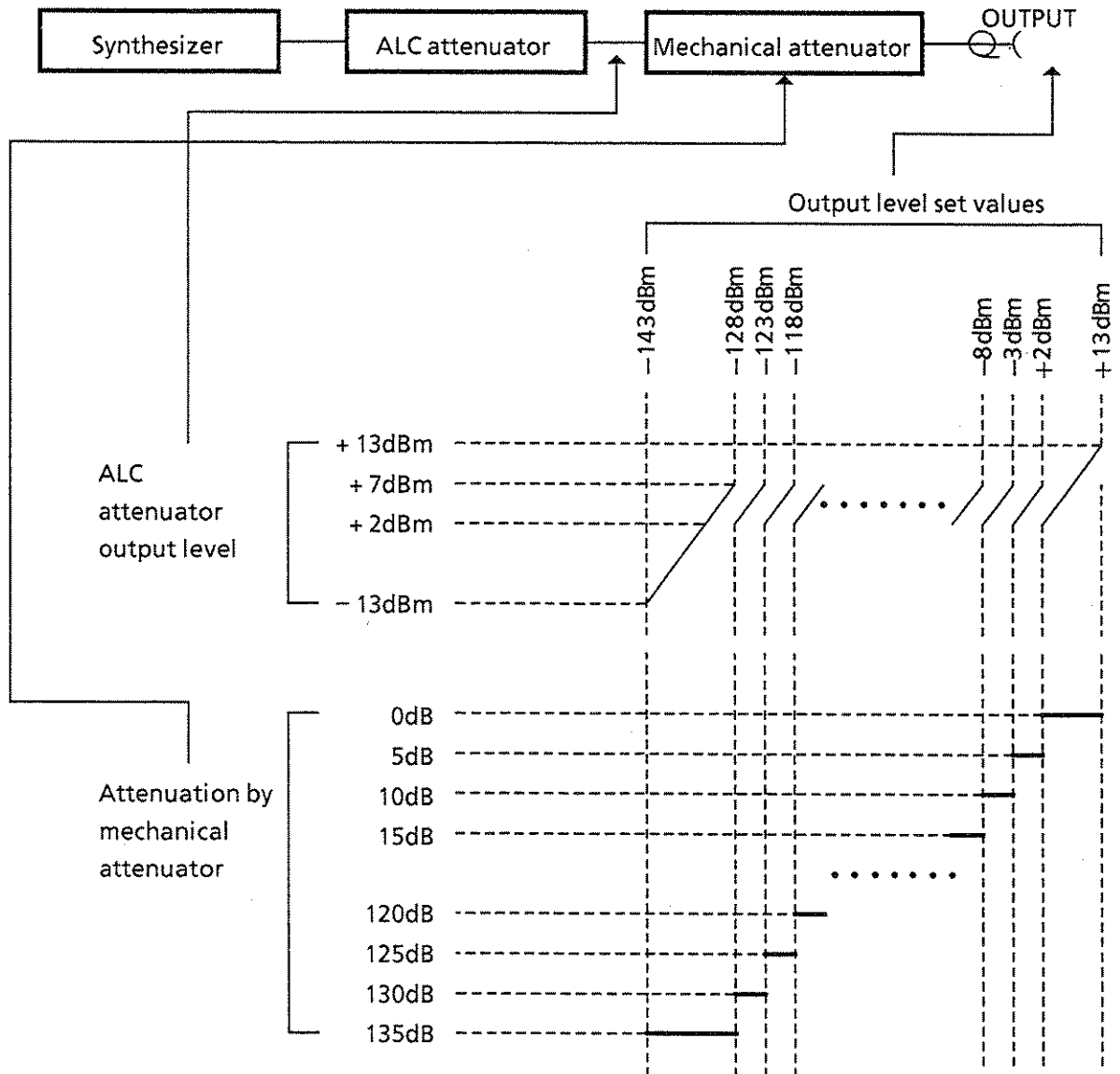

The above method of setting has an advantage in that the output level can be set in a wide range with high accuracy and high resolution. If the output level is changed, however, it presents a drawback that the signal is momentarily disconnected because the mechanical attenuator is actuated every 5 dB.

To prevent this problem, the MG3631A/MG3632A employs a unique scheme called the output level continuous variable mode where the output level is changed without momentary interruption within the variable range of the ALC attenuator while keeping the mechanical attenuator idle.

The output level continuous variable mode can be set by pressing INCR [V] (CONTINUOUS key) after pressing [SHIFT]. "CONT" is displayed on the OUTPUT LEVEL display, and this indicates that the unit is placed in the output level continuous variable mode.

When the unit is placed in the output level continuous variable mode, the functions of the increment step key and rotary knob change as follows:

- Increment step key: Used to set the attenuation achieved by the mechanical attenuator. The attenuation of the mechanical attenuator increments or decrements by 5 dB each time the key is pressed, so the output level changes in 5 dB each time. Thus, as a result, the unit operates in the same way as the increment step value is set to 5 dB.
- Rotary knob: Used to set the output level of the ALC attenuator. The output level of the ALC attenuator can be changed in the range of +13 to -20 dBm. The set resolution is the 0.1 dB's digit place for units of dBm and dB μ or the lowest digit place on the display for units of μ V, mV, and V.

When in the output level continuous variable mode, the output level can be changed without momentary interruption in the following range relative to the output level that is set when the unit is placed in the continuous variable mode:

Output level that is set when in the continuous variable mode	Range of output levels that can be changed with the rotary knob
+13 to +2.1 dBm	+13 to -20 dBm
+2 to -2.9 dBm	+8 to -25 dBm
-3 to -7.9 dBm	+3 to -30 dBm
-8 to -12.9 dBm	-2 to -35 dBm
-13 to -17.9 dBm	-7 to -40 dBm
-18 to -22.9 dBm	-12 to -45 dBm
-23 to -27.9 dBm	-17 to -50 dBm
-28 to -32.9 dBm	-22 to -55 dBm
-33 to -37.9 dBm	-27 to -60 dBm
-38 to -42.9 dBm	-32 to -65 dBm
-43 to -47.9 dBm	-37 to -70 dBm
-48 to -52.9 dBm	-42 to -75 dBm
-53 to -57.9 dBm	-47 to -80 dBm
-58 to -62.9 dBm	-52 to -85 dBm
-63 to -67.9 dBm	-57 to -90 dBm
-68 to -72.9 dBm	-62 to -95 dBm
-73 to -77.9 dBm	-67 to -100 dBm
-78 to -82.9 dBm	-72 to -105 dBm
-83 to -87.9 dBm	-77 to -110 dBm
-88 to -92.9 dBm	-82 to -115 dBm
-93 to -97.9 dBm	-87 to -120 dBm
-98 to -102.9 dBm	-92 to -125 dBm
-103 to -107.9 dBm	-97 to -130 dBm
-108 to -112.9 dBm	-102 to -135 dBm
-113 to -117.9 dBm	-107 to -140 dBm
-118 to -122.9 dBm	-112 to -143 dBm
-123 to -127.9 dBm	-117 to -143 dBm
-128 to -143.0 dBm	-122 to -143 dBm

Example: Set the unit in continuous variable mode when the output level is set to -10 dBm and change it to -15 dBm without causing momentary interruption.

1. [LEVEL]
2. [+/-] [1] [0] [GHz/dBm]

Set the unit in the output level setting mode.

Set the output level to -10 dBm.



3. [SHIFT] INCR [V]

Sets the unit in the continuous variable mode. "CONT" is lit on the OUTPUT LEVEL display.



4. Turn the rotary knob counterclockwise.

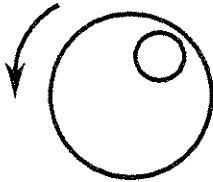

Turn the rotary knob counterclockwise until the output level is decremented to -15 dBm.

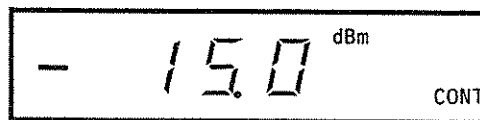

When the output level is set using the data keys while in the continuous variable mode, the ALC and mechanical attenuators are both set in the same way as in normal mode, but the continuous variable mode is not cleared.

To clear the continuous variable mode, press [SHIFT], then INCR [^] (NORMAL key). The ALC and mechanical attenuators are reset to the values set in normal mode without changing the current value of the output level. The functions of the INCREMENT [^] [v] and rotary knob are restored to those that were available before setting the continuous variable mode. And "CONT" on the OUTPUT LEVEL display goes out and this indicates that the unit is now in normal mode.

4.2.6 Displaying relative level

(1) Setting relative-level display mode

When [RELATIVE] beside the OUTPUT LEVEL display is pressed while an output level is displayed on the OUTPUT LEVEL display, the value is set to 0 dB. That level becomes the relative level mode reference value 0 dB.

At this time [RELATIVE] LED is lit and plus or minus sign is lit at the left most digit of the OUTPUT LEVEL display to indicate the relative level display mode.

The actual output level in the relative level display mode can be obtained using the following equation.

$$\text{Output level} = \boxed{\text{Output level when [RELATIVE] is pressed}} + \boxed{\text{Current relative value displayed}}$$

When checking the relative level is desired mode is selected even if the output level before setting the relative-level display mode is unit μV , mV, or V, the unit changes to dB, and variable display with the INCREMENT [\wedge] [\vee] and rotary knob are all made in dB.

Level setting with [RELATIVE] is possible.

(2) Checking actual output level during relative level display mode

When checking the actual output level is desired during the relative level display mode, continue to press [RELATIVE] (CUR DSPL key) after pressing [SHIFT]. The actual output level is displayed while the key is held down, and when released the relative level is displayed again.

(3) Exiting relative-level display mode

Press [RELATIVE] again to exit the relative-level display mode. The output level at this time is the output level indicated immediately before the relative-level display mode is exited.

4.2.7 Output level offset setting mode

Output level offset setting refers to a function that offsets the set and displayed values against the actual output level by value you set as an offset value.

Press [SHIFT], [5] (L-OFS key), numeric data keys and [GHz/dBm] (dB keys) in this order to set an offset value. When an offset value is set, the set and displayed values are offset against the actual output level by that offset value.

Offset values can be set in the range of -55 dB to 55 dB. Press [SHIFT], [5] (L-OFS key), [0] and [GHz/dBm] (dB keys) in this order to clear output level offset settings. The offset value is reduced to 0 dB and the set and displayed values match the actual output level.

When the output level offset is set (i.e., offset value is not 0 dB), "OFS" is displayed on the OUTPUT LEVEL display to indicate the output level offset is set.

The actual output level when the output level offset is set can be obtained using the following equation.

$$\text{Actual output level} = \boxed{\text{Output level set from panel or via GP-IB and output level read from display or via GP-IB}} - \boxed{\text{Level offset value}}$$

When an actual output level check is required, continue to [RELATIVE] (CUR DSPL key) after pressing [SHIFT]. The actual output level is displayed while the key is held down. And when released, the output level is displayed again.

Example: Set the level offset value to 10 dB, set an output level to -100 dBm from the panel, and output -100 dBm - 10 dB = -110 dBm via the output connector.

1. [SHIFT] [5] [1] [0] [GHz/dBm] Set the output level offset value to 10 dB.
2. [LEVEL] [+/-] [1] [0] [0] [GHz/dBm] Set the output level to -100 dBm.
Although -100 dBm is displayed at this time, the actual output level is -110 dBm.



When the offset value check is required, press [5] (L-OFS key) for 0.5 seconds or more after pressing [SHIFT]. The display is returned to the previous display when the [5] (L-OFS key) is released.

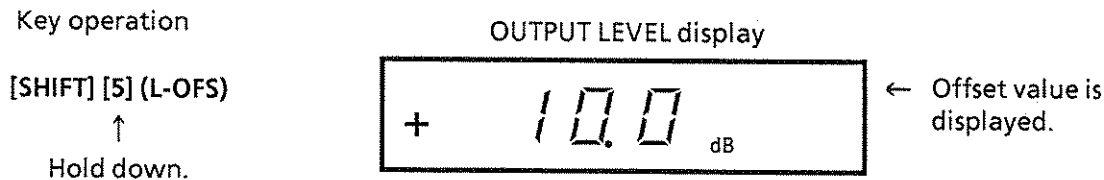

4.2.8 Turning output signal ON/OFF

The output signal can be turned OFF using [RF OFF/ON]. When [RF OFF/ON] is pressed again, the output signal is turned ON again (the previous level before it was turned OFF).

When the output signal is OFF, "OFF" is displayed on the OUTPUT LEVEL display.



The output signal can be alternately turned ON or OFF by pressing [RF OFF/ON], and the output signal OFF can also be released by following three procedures described below:

(1) Releasing output signal OFF using data keys

The output signal OFF can be released by pressing [LEVEL] and unit key. The OUTPUT LEVEL display after releasing is displayed in the unit the pressed unit key. When [LEVEL], numeric keys, and unit key are pressed, the output signal OFF can be released and the new output level can be set.

(2) Releasing output signal OFF using rotary knob

When the rotary knob is turned clockwise or counterclockwise by one click, the output signal OFF can be released. When it is turned by two clicks or more, the usual rotary knob operation is obtained.

(3) Releasing output signal OFF using INCREMENT [^] [v]

When either INCR [^] or [v] key is pressed once, the output signal OFF can be released. When it is pressed the second time or thereafter, the usual increment step key operation is obtained.

Note: Both the ALC and mechanical attenuators are set to maximum attenuation in the output signal OFF status. Therefore, -143 dBm or less can be output with the 50 ohms impedance OUTPUT connector.

4.2.9 Operating and releasing reverse power protective circuit (RPP)

The MG3631A/MG3632A is provided with a reverse power protection circuit in the output section to protect an internal circuit from excessive reverse input power. When the RPP circuit operates, "RPP" is displayed on the OUTPUT display and the [STATUS] LEDs blink.

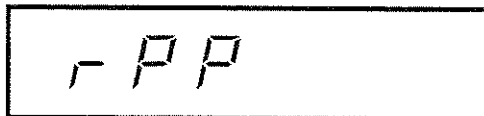

Press [RF OFF/ON](RPP RESET key) after pressing [SHIFT] to release the operation of RPP circuit.

CAUTION

Since the RPP circuit uses mechanical switch, the contact may be worn out and damaged if excess reverse power is applied repeatedly. Therefore, do not apply reverse power as such as possible. Also, never release the RPP circuit with reverse power applied; otherwise, it will cause trouble with the RPP circuit.

The RPP circuit can protect internal circuits against reverse power surges of up to 50 VDC, 50 W (up to 1040 MHz) or 25 W (1040 to 2080 MHz). Never apply a reverse power exceeding these limits.

Since an impedance of OUTPUT connector is opened while the RPP circuit is operating, care should also be taken not to damage the transmitter or the device.

Note: If the output level is set to a value below -133 dBm, the [STATUS] LED lights. At this time, pressing [STATUS] displays the following error message on the display while the key is held down and indicate that the output signal characteristics are not guaranteed.



If an erroneous output level is set, [STATUS] LED lights and the previous output level is displayed. At this time, pressing [STATUS] displays the following error message on the display while the key is held down.



... Attempted to set output level outside the setting range.



... Any key other than the unit key was pressed during or after numeric data entry.

If the ALC attenuator output level is set in a range of -13 to -20 dBm using the rotary knob in the continuous variable mode, the absolute value of the output level cannot be guaranteed. At this time, [STATUS] LED lights and the following error message is displayed on the display while [STATUS] is held down.

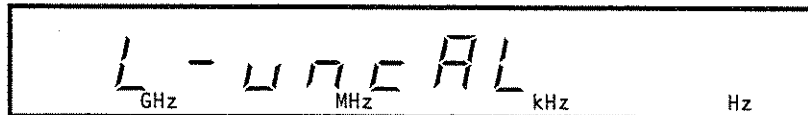

4.3 Setting Modulation Functions

The MG3631A/MG3632A is provided with AM (amplitude modulation) and FM (frequency modulation) functions. Simultaneous AM and FM modulations is not possible, however.

The following describes the modulation range:

- AM: 0 to 100%
- FM: 0 to 200 kHz (However, 0 to 100 kHz in the carrier frequency range of 130 to 260 MHz)

Any desired modulation signal can be selected from the following four:

- 1 kHz (sine wave)
- 400 Hz (sine wave)
- EXT (external modulating input signal; specified input level 2 Vp-p/600 ohms)
- AF (0.1 Hz to 100 kHz sine wave with 0.1 Hz resolution; this is only available when option 04 (AF oscillator) is installed however).

The MG3631A/MG3632A has a modulation signal MIX function, so it is possible to apply modulation after synthesizing the modulation signal selected first from the four sources available (MAIN modulation signal) with another modulation signal (MIX modulation signal). The following table lists the combinations of signals that can be synthesized using the MIX function.

MAIN modulation signal	MIX modulation signal
1 kH	EXT or AF
400 Hz	EXT or AF
EXT	AF
AF	EXT

4.3.1 Outline of modulation setting procedure

To set modulation functions, follow the procedure described below:

(1) Setting modulation mode

Press [AM ON/OFF] or [FM ON/OFF] in the MODULATION zone to turn ON the desired modulation function.

The MODULATION display shows the modulation mode (AM or FM) just set and the modulation factor or frequency deviation set in the previous modulation mode (initial value: AM 30% or FM 3.5 kHz). At the same time, one of the 1 kHz, 400 Hz, EXT, or AF LEDs in the SOURCE section (modulation signal set in the previous modulation mode; initially 1 kHz) lights. In addition, if the MIX function was used in the previous modulation mode, either EXT or AF LED in the MIX area (both initially OFF) lights.

(2) Setting modulation signal

Press the key in the SOURCE section to select the modulation signal (1 kHz, 400 Hz, EXT, or AF). Pressing the SOURCE section key sets in order of 1 kHz, 400 Hz, EXT, AF, 1 kHz. Note, however, that AF is omitted unless option 04 is installed in the unit.

(3) Setting MIX modulation signal (only when using synthesized modulation)

Press the MIX key in the SOURCE section to select the modulation signal (EXT or AF) that you want to be mixed with the MAIN modulation signal. If synthesized modulation is not used, make sure both EXT and AF LEDs are OFF.

Pressing the MIX key sets in order of EXT, AF, OFF, EXT, AF, and so on each time you press the MIX key. Note, however, that AF is omitted unless option 04 is installed in the unit.

(4) Setting modulation factor or frequency deviation

Set [MOD], numeric keys, and [kHz/mV] (% key) in this order. The modulation factor or frequency deviation can be changed using the [∧] or [∨] key in the MODULATION section. If the [MOD] is pressed when the modulation function is OFF, the modulation mode, modulation factor or frequency deviation, and modulation signal that were set last are turned ON. (These settings are initially FM mode, 3.5 kHz deviation, and 1 kHz modulation signal.)

(5) Setting modulation factor or frequency deviation of MIX modulation signal (only when using synthesized modulation)

Set [SHIFT], [MOD] (MOD MIX key), numeric keys, and [kHz/mV] (% key). [SHIFT] and [MOD] (MOD MIX key) are ignored when pressed while the modulation factor or MIX modulation signal is OFF.

(6) Setting AF frequency (only when using AF as the modulation signal)

Set [SHIFT], [FREQ] (AF key), numeric keys, and unit keys in this order. The AF frequency can be changed using the INCR [∧] and [∨] keys or rotary knob in the FREQUENCY/MEMORY zone.

(7) Adjusting external modulation signal level (only when using EXT as modulation signal)

Adjust the external modulation signal level so that both the H and L LEDs beside the MOD INPUT connector go off.

To turn the modulation function OFF, press the currently set modulation mode key ([AM ON/OFF] or [FM ON/OFF]).

If the other modulation mode key (e.g., [FM ON/OFF] when AM modulation is ON) is pressed, the current set modulation is turned OFF and, at the same time, modulation for the pressed modulation mode key is turned ON.

Example: Apply FM modulation using 1 kHz modulation frequency with 3 kHz frequency deviation and 88.5 Hz modulation frequency with 0.5 kHz frequency deviation.

1. [FM ON/OFF]

Turn the FM modulation ON.
Sets the previous set FM modulation status.

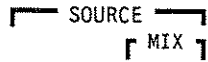

- 1kHz
- 400Hz
- EXT EXT
- AF(OPT) AF(OPT)

2. Press the SOURCE section key to select 1 kHz.

The 1 kHz LED lights (already 1 kHz after initialization).

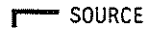

- 1kHz
- 400Hz
- EXT
- AF(OPT)

3. Press the MIX key in the SOURCE section to select AF.

The AF LED lights.

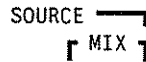

- EXT
- AF(OPT)

4. [MOD] [3] [kHz/mV]

Set the frequency deviation to 3 kHz.



(Continued)

5. [SHIFT] [MOD] [0] [.] [5] [kHz/mV]

Set the frequency deviation of the MIX modulation signal to 0.5 kHz.



6. [SHIFT] [FREQ] [8] [8] [.] [5] [Hz/ μ V]

Set the AF frequency to 88.5 Hz. The AF frequency is displayed on the FREQUENCY display.



4.3.2 Setting FM frequency deviation

There are two different procedure for setting the FM frequency deviation.

- Data keys
- [^]/[v] keys

Frequency deviation range 0 Hz to 200 kHz

Initial value of frequency deviation 3.5 kHz

Frequency deviation can be set in up to 200 kHz regardless of the carrier frequency. However, the actual applicable range of FM modulation changes depending on the carrier frequency as shown below:

Carrier frequency	Range of frequency deviation
Up to 130 MHz	0 to 200 kHz
130 MHz to less than 260 MHz	0 to 100 kHz
260 MHz or more	0 to 200 kHz

The minimum resolution of frequency deviation changes depending on the frequency deviation range. The following shows the relationship between frequency deviation range and minimum resolution.

Frequency deviation range	Minimum resolution
0 to 9.99 kHz	0.01 kHz
10 to 99.9 kHz	0.1 kHz
100 to 200 kHz	1 kHz

When the MIX modulation is used, the set resolution of each frequency deviation for MAIN and MIX is the minimum resolution of the frequency deviation whichever larger. For example, when the deviation for MAIN is 150 kHz and that for MIX is 3.52 kHz, the deviation for MIX is rounded off to 3 kHz as it is set because the resolution for the MAIN deviation is 1 kHz.

(1) Setting frequency deviation using data keys

When the FM modulation mode is ON or the last used modulation mode is FM modulation, press [MOD], numeric data keys, and unit keys in this order to set frequency deviation.

To set frequency deviation for the MIX modulation signal, press [SHIFT], [MOD] (MOD MIX key), numeric data key, and unit keys. However, the [SHIFT] and [MOD] (MOD MIX key) are ignored when pressed while the modulation function or MIX modulation signal is OFF.

Any desired unit key can be selected from [MHz/dB μ], [kHz/mV], and [Hz/ μ V].

Example: Set the frequency deviation of the MAIN modulation signal to 75 kHz and that of the MIX modulation signal to 5.2 kHz.

[MOD] [7] [5] [kHz/mV]

[SHIFT] [MOD] [5] [.] [2] [kHz/mV]

When in frequency deviation setting mode for the MIX modulation signal, "MIX" is displayed on the left most digit of the MODULATION display.

Pressing [MOD] (MOD MIX key) or pressing [MOD] after [SHIFT] place the unit in the frequency deviation setting mode for the MAIN or MIX modulation signal and the unit remains in this mode unless some other FUNCTION key is pressed. Therefore, frequency deviations can be sequentially set only by pressing the numeric data keys and unit keys.

When entering frequency deviation, select the unit key (Hz, kHz, or MHz) so that the input data will be within three digits. Note, however, that display on the MODULATION display immediately after completion of data input is in units of kHz regardless of which unit key was pressed when entering the data.

When the MIX modulation is used, the set resolution of each frequency deviation for MAIN and MIX is the minimum resolution of the frequency deviation whichever larger. For example, when the deviation for MAIN is 150 kHz and that for MIX is 3.52 kHz, the deviation for MIX is rounded off to 3 kHz as it is set because the resolution for the MAIN deviation is 1 kHz.

(2) Setting frequency deviation using [^]/[v] keys

By pressing [^] or [v] in the MODULATION zone, the frequency deviation of the current displayed modulation signal (MAIN or MIX) can be incremented or decremented in any desired digit.

By pressing [^] (RESOL [<] key) or [v] (RESOL [>] key) after pressing [SHIFT] in the MODULATION zone, the variable digits can be selected from the three displayed on the MODULATION display among four: 10 kHz, 1 kHz, 0.1 kHz, and 0.01 kHz. The initial value of the variable digit is 0.1 kHz.

Example: After setting the frequency deviation to 3.5 kHz, change it with a 0.01 kHz resolution.

1. [MODE] Set the unit in the frequency deviation setting mode.
2. [3] [.] [5] [kHz/mV] Set the frequency deviation to 3.5 kHz.
3. [SHIFT] [v] ([>]) in MODULATION zone Press the key repeatedly until the 0.01 kHz digit on the MODULATION display blinks.
4. [^] or [v] in MODULATION zone Change the frequency deviation in 0.01 kHz steps.

The frequency is incremented or decremented in the preselected digit each time the [^] or [v] is pressed. In addition, the frequency can be incremented or decremented continuously by holding down the key for about 1 second or more.

When [^] (RESOL [<] key) or [v] (RESOL [>] key) in the MODULATION zone is pressed after pressing [SHIFT], the display of the resolution digit left or right to the current set resolution digit blinks one time and the resolution digit moves. Then, the resolution digit can be set by repeating this operation.

Key operation

[SHIFT] [^] (RESOL [<])
Hold down the key until the figure at the desired resolution digit on the display begins to blink.

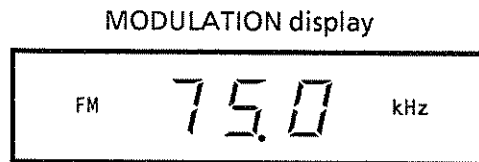

[SHIFT] [v] (RESOL [>])
Hold down the key until the figure at the desired resolution digit on display begins to blink.



Note: In the following cases, the set frequency deviation exceeds the frequency deviation for which FM modulation an actually be applied. Therefore, it is set to the maximum frequency deviation for the frequency then used and the [STATUS] LED lights.

- Frequency deviation is set to 100 kHz or more in the frequency range under 130 to 260 MHz.
- Frequency is set in a range under 130 to 260 MHz while frequency deviation exceeds 100 kHz.

At this time, press the [STATUS] and the following error message is displayed on the display while the key is held down. At the same time, the MODULATION display shows "100 kHz", that is, the maximum frequency deviation at 130 to 260 MHz.



In the following cases, since the set FM modulation exceeds the specified range, [STATUS] LED lights.

- The carrier frequency is set to less than 500 kHz when FM is selected.
- The sum of MAIN and MIX frequency deviations exceeds the specified range.

At this time, press the [STATUS] and the following error message is displayed while the key is held down.



If an erroneous frequency deviation is set, [STATUS] LED lights and the previous is displayed. At this time, press [STATUS] and an error message is displayed while the key is held down.

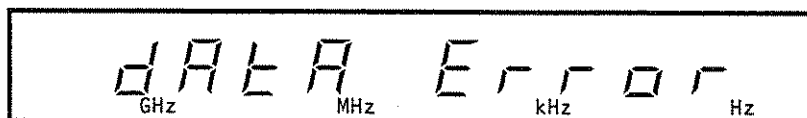

... Attempted to set frequency deviation outside the setting range.

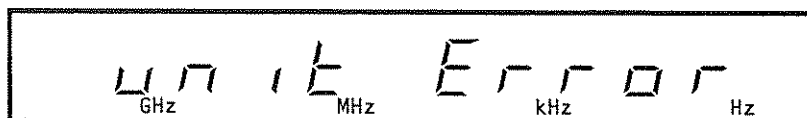

... Any key other than the unit key was pressed during or after numeric data entry.

4.3.3 Setting AM modulation

There are following procedures to set the AM modulation factor:

- Data keys
- [^]/[v]

Modulation factor setting range	0% to 100%
Minimum resolution of modulation factor setting	1%
Initial value of modulation factor	30%

(1) Setting modulation factor using data keys

When AM modulation mode is ON or the last used modulation mode is AM modulation, modulation factor can be set by pressing [MOD], numeric data keys, and [kHz/mV] (% key) in this order.

Press [SHIFT], [MOD] (MOD MIX key), numeric data keys, and [kHz/mV] (% key) in this order to set the modulation factor of the MIX modulation signal. However, [SHIFT] and [MOD] (MOD MIX key) are ignored when pressed while the modulation function or MIX modulation signal is OFF.

Example: Set the modulation factor of the MAIN modulation signal to 75% and that of the MIX modulation signal to 15%.

```
[MOD] [7] [5]      [kHz/mV] (%)
[SHIFT] [MOD] [1] [5]  [kHz/mV] (%)
```

In modulation factor setting for the MIX modulation signal, "MIX" is displayed at the left most digit of the MODULATION display.

Pressing [MOD] (MOD MIX key) or pressing [MOD] after [SHIFT] sets the unit in the modulation factor setting mode for the MAIN or MIX modulation signal and the unit remains in this mode unless some other FUNCTION key is pressed. Therefore, the modulation factors is sequentially set only by entering numeric data and [kHz/mV] (% key).

(2) Setting modulation factor using [^]/[v] keys

By pressing [^] or [v] in the MODULATION zone, the modulation factor of the current displayed modulation signal (MAIN or MIX) can be incremented or decremented in any desired digit.

By pressing [^] (RESOL [<] key) or [v] (RESOL [>] key) after pressing [SHIFT] in the MODULATION zone, the variable digits can be selected from the two: a 1% and 10% digit.

The initial value of the variable digit is 1%.

Example: After setting the modulation factor to 30%, change it with a 10% resolution.

1. [MODE] Set the unit in the modulation factor setting mode.
2. [3] [0] [kHz/mV] (%) Set the modulation factor to 30%.
3. [SHIFT]
[v] ([<]) in MODULATION zone Press the key repeatedly until the 10% digit on the MODULATION display blinks.
4. [^] or [v] in MODULATION zone Change the modulation factor in 10% steps.

The modulation factor is incremented or decremented in the preselected digit each time [^] or [v] is pressed. In addition, the modulation factor can be incremented or decremented continuously by holding down the key for about 1 second or more.

When [^] (RESOL [<] key) or [v] (RESOL [>] key) in the MODULATION zone is pressed after pressing [SHIFT], the display of the resolution digit left or right to the current set resolution digit blinks one time and the resolution digit moves.

- Key operation**
- [SHIFT] [^] (RESOL [<])
Hold down the key until the figure at the desired resolution digit on the display begins to blink.
- [SHIFT] [v] (RESOL [>])
Hold down the key until the figure at the desired resolution digit on the display begins to blink.

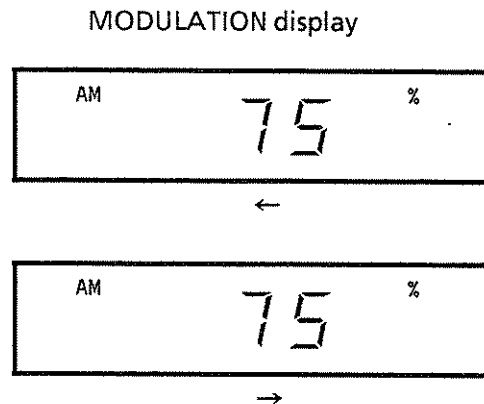

Note: In the following cases, the set AM modulation exceeds the designated range, and [STATUS] LED lights.

- Modulation factor is set to 91% or more regardless of the carrier frequency.
- The carrier frequency is set to less than 400 kHz while AM is ON.
- The sum of MAIN and MIX modulation factors exceeds 91%.
- The output level (during normal mode) exceeds +7 dBm.
- The ALC attenuator output level (during continuous variable mode) exceeds +7 dBm or is less than 0 dBm.

At this time, press [STATUS] and the following error message is displayed on the display while the key is held down.

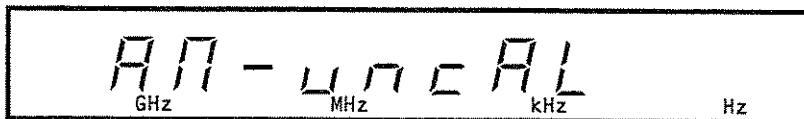

If an erroneous modulation factor is set, [STATUS] LED lights and the previous modulation factor is displayed. At this time, press [STATUS] and an error message is displayed while the key is held down.

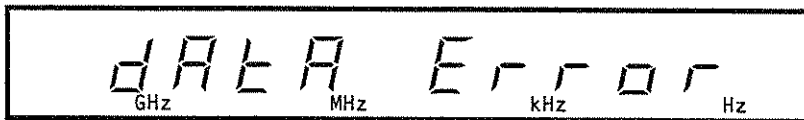

... Attempted to set modulation factor outside the designated range.

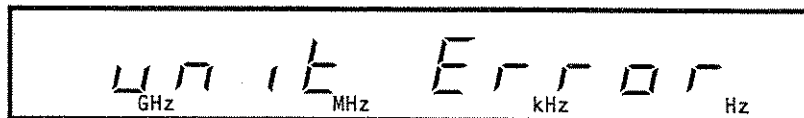

... Any key other than the [kHz/mV] (% key) was pressed during or after numeric data entry.

4.3.4 Setting the frequency of AF oscillator (option)

There are following procedures to set the AF frequency.

- Data keys
- Increment step key
- Rotary knob

AF frequency range 0.1 Hz to 100 kHz
 Minimum resolution of AF frequency setting 0.1 Hz
 Initial value of AF frequency 1 kHz

The procedure of setting the AF frequency is basically the same as setting the carrier frequency. However, a relative frequency cannot be displayed and an offset frequency cannot be set.

The AF frequency can be set even when modulation is OFF.

Note: Since the AF oscillator is optional, the AF frequency cannot be set if option is not installed in the unit. If the AF frequency is set while the option is not installed, [STATUS] LED lights. When [STATUS] is pressed at this time, an error message is displayed on the display while you hold down the key.



(1) Reading the AF frequency during carrier frequency display

Since AF frequency shares the same FREQUENCY display with the carrier frequency, select the indication contents in the following procedure.

- To display carrier frequency Press [FREQ].
- To display AF frequency Press [SHIFT], then [FREQ] (AF key).
 "AF" is displayed at the left most digit of the FREQUENCY display to show the AF frequency.

Example: After setting the carrier frequency to 510 MHz, let the display show the previously set AF frequency (that is, 23 kHz).

1. [FREQ] Set the unit in the frequency setting mode.
2. [5] [1] [0] [MHz/dBμ] Set the carrier frequency to 510 MHz.

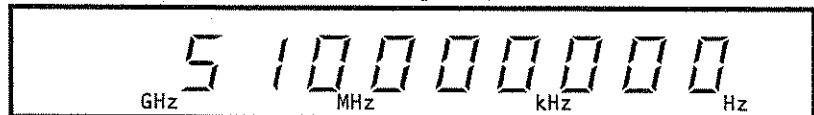

3. [SHIFT] [FREQ] (AF) The AF frequency is displayed.

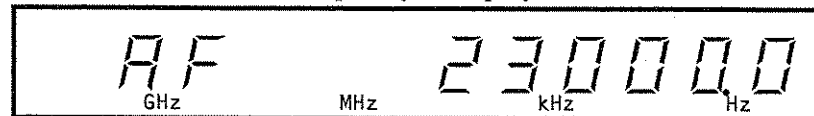

(2) Setting AF frequency using data keys

Press [SHIFT], [FREQ] (AF key), numeric data keys, and unit keys in this order.

Any desired unit key can be selected from the four units available: [GHz/dBm], [MHz/dBμ], [kHz/mV], and [Hz/μV].

Example: Set an AF frequency

88.5 Hz → [SHIFT] [FREQ] [8] [8] [.] [5] [Hz/μV]

1.2 kHz → [SHIFT] [FREQ] [1] [.] [2] [kHz/mV]

Pressing [FREQ] (AF key) after pressing [SHIFT] sets the unit in the AF frequency setting mode and the unit remains in this mode unless some other FUNCTION key is pressed. Therefore, AF frequencies can be set only by entering numeric data and unit key repeatedly.

(3) Setting AF frequency using INCREMENT [^] [v]

Pressing [FREQ] (AF key) after pressing [SHIFT] sets the unit in the AF frequency setting mode. At this time, AF frequency can be incremented or decremented at equal intervals by operating INCR [^] or [v] in the FREQUENCY/MEMORY zone.

Press [SHIFT], [FREQ] (AF key), [INCR SET], numeric data keys, and unit keys in order to set the increment step value. If the unit is already in the AF frequency setting mode, it is not necessary to press [FREQ] (AF key) again after pressing [SHIFT].

Increment step value setting range 0.1 Hz to 99.9999 kHz

Initial value of increment step value 100 Hz

Example: After setting the AF frequency to 400 Hz, increment and decrement frequencies in every 12 Hz steps around that AF frequency.

1. [SHIFT] [FREQ] (AF) Set the unit in the AF frequency setting mode.
2. [4] [0] [0] [Hz/μV] Set the AF frequency to 400 Hz.
3. [INCR SET] [1] [2] [Hz/μV] Set the increment step value to 12 Hz.
4. Press [^] one time. The frequency is incremented by 12 Hz to 412 Hz.
5. Press [v] one time. The frequency is decremented by 12 Hz back to 400 Hz.

The AF frequency is incremented or decremented in units of frequencies set as the increment step value each time you press INCR [^] or [v]. In addition, the AF frequency can be incremented or decremented continuously by holding down the key for about 1 second or more.

To confirm the increment step value, hold down [INCR SET] for 0.5 seconds or more.

Key operation	MODULATION display	
[INCR SET] ↑ Hold down.		← Increment step value is displayed.

(4) Setting AF frequency using rotary knob

Pressing [FREQ] (AF key) after pressing [SHIFT] sets the unit in the AF frequency setting mode. At this time, AF frequency can be incremented or decremented in any desired digit by turning the rotary knob in the FREQUENCY/MEMORY zone.

The digits in which you want the frequency to be changed can be selected from six - from a 0.1 Hz to a 10 kHz digit - by pressing the RESOLUTION [<] or [>] key in the FREQUENCY//MEMORY zone. The initial value of the variable digit is 100 Hz.

Example: After setting the AF frequency to 400 Hz, change it with a 0.1 Hz resolution.

1. [SHIFT] [FREQ] (AF) Set the unit in the AF frequency setting mode.
2. [4] [0] [0] [Hz/ μ V] Set the AF frequency to 400 Hz.
3. RESOLUTION [<] or [>] Hold down the key until a 0.1 Hz digit on the FREQUENCY display blinks.
4. Turn the rotary knob clockwise or counterclockwise. The AF frequency is changed in 0.1 Hz steps.

When the RESOLUTION [<] or [>] is pressed, the digit at the left or right of the current set resolution digit blinks one time. When the key is pressed again or held down for about 1 second or more, the blinking digit moves to the left or right side of the display one digit's place at a time and the resolution digit moves sequentially in this way.

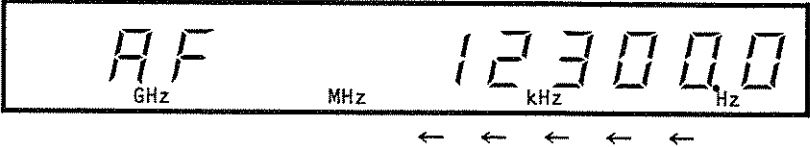
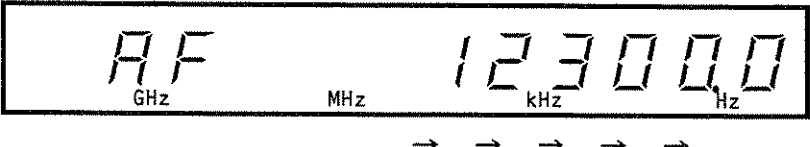
Key operation	FREQUENCY display
<p>RESOLUTION [<] Hold down the key until the figure at the desired resolution digit on display begins to blink.</p>	
<p>RESOLUTION [>] Hold down the key until the figure at the desired resolution digit on display begins to blink.</p>	

When RESOLUTION [>] (KNOB INCR key) is pressed after pressing [SHIFT], the AF frequency can be incremented or decremented using the rotary knob in units of the increment step value described in (3) above.

When RESOLUTION [>] (KNOB INCR key) is pressed after pressing [SHIFT] or the RESOLUTION [<] or [>] is pressed, the numeric display of the previously set resolution digit blinks one time and normal rotary knob operation is restored.

Note: If an erroneous AF frequency is set, [STATUS] LED lights and the previously set AF frequency is displayed. At this time, press [STATUS] and an error message is displayed on the display while the key is held down.



... Attempted to set AF frequency outside the designated range.



... Any key other than the unit key was pressed during or after numeric data entry.

4.3.5 External modulation signal

When EXT is selected for the modulation frequency, modulation is applied using the signal input to the MOD INPUT connector on the front panel.

(1) Switching between AC and DC

The modulation input signal can be selected between AC and DC coupling.

For AC/DC switching, press [COUPLE] when EXT is selected as the modulation signal. AC and DC are alternately set each time the key is pressed. AC coupling is set when [COUPLE] LED is OFF; DC coupling is set when the LED is ON.

When AC coupling is selected, modulation can be applied for frequencies of 20 Hz and more. When DC coupling is selected, modulation can be applied beginning with DC. AC/DC can be independently set in AM and FM modulation modes. In the initial status, the setting is AC coupling for both AM and FM.

(2) Switching modulation input polarities

The modulation input signal can be inverted of its polarity.

To invert the signal polarity, press [SHIFT] and then [COUPLE] (POLARITY key). To restore the polarity back, press [SHIFT] and then [COUPLE] (POLARITY key) again. When the polarity is inverted, "INVS" is displayed on the MODULATION display.

The modulation input polarity can be independently set in AM and FM modulation modes each. In the initial status, the polarity is not inverted in both AM and FM ("INVS" is OFF).

(3) Modulation input level

When the modulation input signal is set to 2 Vp-p, the actual obtained modulation factor or frequency deviation matches the set value.

The input impedance of the MOD INPUT connector is 600 ohms.

The modulation input signal level is 2 Vp-p when both the H and L LEDs beside the MOD INPUT connector are turned OFF.



H ← Level is excessively large

L ← Level is excessively small

If the frequency of the modulation input signal is 50 Hz or less, adjust the signal level so that H and L alternately turns ON.

The modulation factor or frequency deviation can be changed with the modulation signal by changing its level. At this time, the actual obtained modulation factor or frequency deviation can be obtained using the following equation.

$$\boxed{\text{Actual obtained modulation factor of frequency deviation}} = \boxed{\text{Set value of modulation factor or frequency deviation}} \times \frac{X (V_{p-p})}{2 (V_{p-p})}$$

X: Modulating signal input level

Note: When during FM modulation, DC is selected by AC/DC switching, FM modulation from DC upward is possible by unlocking the internal PLL circuit. For this reason, the accuracy and stability of the carrier frequency are inferior to those obtained in CW or AC FM. Unless applying FM modulation from DC up, be sure to select AC.

4.3.6 Modulation output

The current applied MAIN modulation signal can be monitored via the MOD OUTPUT connector on the panel.

The signal level output via the MOD OUTPUT connector is approx. 2 Vp-p for the internal modulation signal and almost the same as the input level in the case of an external modulation signal.

The output impedance of the MOD OUTPUT connector is 600 ohms.

4.4 Function Memory

The MG3631A/MG3632A is provided with the function memory that can store up to 100 panel setting conditions.

The data keys are used to store these setting conditions in memory.

Memory contents can be recalled using the INCREMENT [^] [v] or rotary knob, as well as the data keys. When recalled using the INCREMENT [^] [v] or rotary knob, all data stored in memory is recalled by scanning addresses up and down. But you can skip some memory addresses by making skip setting as necessary.

The memory address are 0 to 99.

4.4.1 Storing in memory

Press [SHIFT], [MEMORY] (MEMORY SET key), numeric data keys and [MHz/dB μ] (STORE key) in this order

Example: Store the following two panel settings in memory addresses 12 and 13.

Memory address	Frequency	Output level	Modulation	Modulation signal
Address 12	12 MHz	- 20 dBm	AM 50%	1 kHz
Address 13	520 MHz	10 dBm	FM 75 kHz	400 Hz

1. [SHIFT] [STATUS] (INITIAL) Initialize the unit.
Setting for address 12
2. [FREQ] [1] [2] [MHz/dB μ] Set the frequency to 12 MHz.
3. [LEVEL] [+ / -] [2] [0] [GHz/dBm] Set the output level to - 20 dBm.
4. [AM ON/OFF] Turn AM modulation ON.
5. [MOD] [5] [0] [kHz/mV] (%) Set the AM modulation factor to 50%.
6. Press the SOURCE section key to select 1 kHz. Select 1 kHz as the modulation signal.
7. [SHIFT] [MEMORY] (MEMORY SET) Set the unit in memory setting mode.
8. [1] [2] [MHz/dB μ] (STORE) The data is stored in memory address 12.
Setting for address 13
9. [FREQ] [5] [2] [0] [MHz/dB μ] Set the frequency to 520 MHz
10. [LEVEL] [1] [0] [GHz/dBm] Set the output level to 10 dBm.
11. [FM ON/OFF] Turn AM modulation OFF and FM modulation ON.
12. [MOD] [7] [5] [kHz/mV] Set the FM frequency deviation to 75 kHz.
13. Press the SOURCE section key to select 400 Hz. Select 400 Hz as the modulation signal.
14. [SHIFT] [MEMORY] (MEMORY SET) Place the unit in memory set mode.
15. [1] [3] [MHz/dB μ] (STORE) The data is stored in memory address 13.

The memory set mode is cleared when memory store is completed, and the unit returns to the setting mode before memory set mode.

4.4.2 Recalling memory contents

There are two methods for memory recall. In one method, memory contents are recalled directly by specifying the address with data keys. With the other method, memory contents are sequentially recalled in order of addresses using the INCREMENT [^][v] or rotary knob.

(1) Memory recall using data keys

Press [MEMORY], numeric data keys, and [GHz/dBm] (RECALL key) in this order.

Example: Recall memory contents at address 12.

[MEMORY] [1] [2] [GHz/dBm] (RECALL)

Pressing [MEMORY] once set the unit the memory recall mode and the unit remains in this mode unless some other FUNCTION key is pressed. Therefore, memory contents can be recalled only by pressing the numeric data keys and the [GHz/dBm] (RECALL keys) repeatedly.

(2) Memory recall using INCREMENT [^][v] or rotary knob

Pressing [MEMORY] sets the unit in the memory recall mode. By operating INCR [^] or [v] in the FREQUENCY/MEMORY zone or the rotary knob, memory contents can be recalled sequentially in the ascending or descending order of addresses.

The memory address increments by 1 each time INCR [^] is pressed or the rotary knob turns clockwise one click in memory recall mode. The memory address decrements by 1 each time INCR [v] is pressed or the rotary knob turns counterclockwise one click in memory recall mode. Memory addressed can also be continuously incremented or decremented by holding down the INCR [^] or [v] for about 1 second or more.

Addresses not stored with any data or to be skipped are not recalled when recalling memory contents. When the start or end addresses is reached recalling, recall is recycled beginning from the start or end address. If data is stored in addresses 12 to 16 and address 15 is set defined to be skipped, for example, memory contents are recalled as shown below:

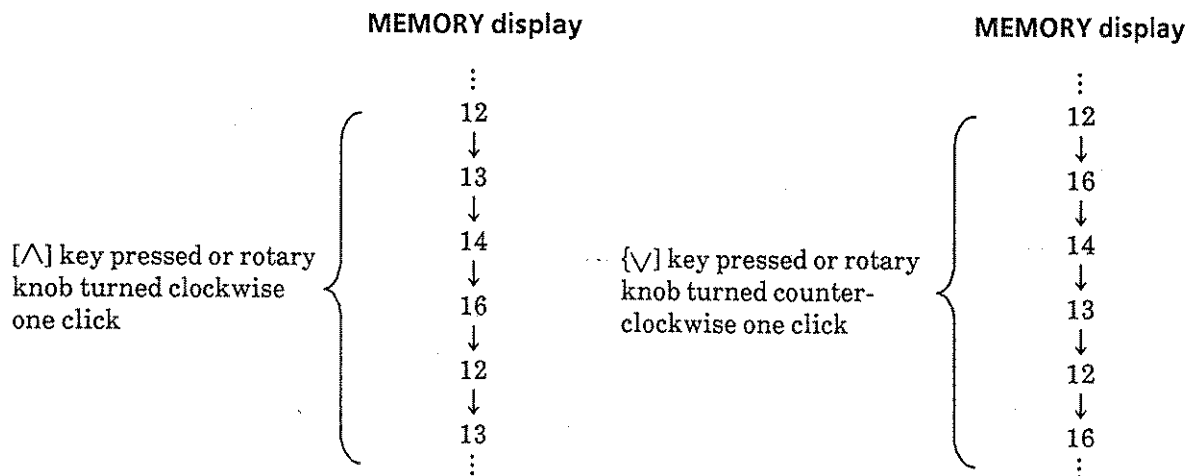

4.4.3 Memory skip setting

Set memory skip to skip some specific addresses in memory recall session using the INCREMENT [^] [v] or rotary knob. Memory contents in addresses set for skip can be normally recalled using the data keys.

Press [SHIFT], [MEMORY] (MEMORY SET key), numeric data keys (address), and [kHz/mV] (SKIP key) in this order to set memory skip. Press [SHIFT], [MEMORY] (MEMORY SET key), numeric data keys (address) and [kHz/mV] (SKIP key) again in order to clear skip setting

When memory contents in addresses set for skip are recalled using the data keys, the decimal point at the lower right corner of the MEMORY display lights, indicating that the memory location is set for skip.

Example: Store the following panel settings in memory address 13 and set this address to be skipped.

- Frequency: 520 MHz, Output level: 10 dBm, Modulation: FM 75 kHz deviation, Modulation signal: 400 Hz

1. [SHIFT] [STATUS] (INITIAL) Initialize the unit.
Setting for address 13
2. [FREQ] [5] [2] [0] [MHz/dB μ] Set the frequency to 520 MHz.
3. [LEVEL] [1] [0] [GHz/dBm] Set the output level to 10 dBm.
4. [FM ON/OFF] Turn FM modulation ON.
5. [MOD] [7] [5] [KHz/mV] Set the FM modulation deviation to 75 kHz.
6. Press the SOURCE section key to select 400 Hz. Select 400 Hz as the modulation signal.
7. [SHIFT] [MEMORY] (MEMORY SET) Set the unit in memory setting mode.
8. [1] [3] [MHz/dB μ] (STORE) Store data in address 13.
Skip setting for address 13
9. [SHIFT] [MEMORY] (MEMORY SET) Set the unit in memory setting mode.
10. [1] [3] [kHz/mV] (SKIP) Address 13 is set for skip

The memory set mode is cleared when the memory skip setting is completed, and the unit returns to the setting mode that is on before memory setting mode.

If the unit is already placed in the memory recall mode by pressing [MEMORY] and some memory address is displayed on the MEMORY display, it is possible to set memory contents at that address to be skipped only by operating [kHz/mV] (SKIP key).

Key operation

MEMORY indicator

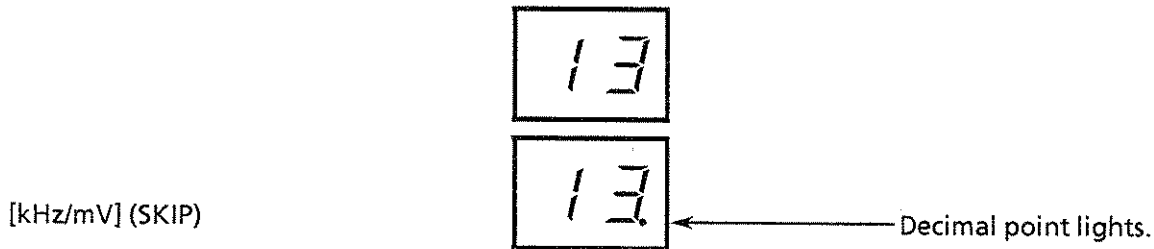

The skip setting cannot be set for addresses not associated with any data.

4.4.4 Memory clear

Press [SHIFT], [MEMORY] (MEMORY SET key), numeric data keys (address), and [kHz/ μ V] (CLEAR key) in this order to delete the data stored in memory.

To delete memory contents from continuous addresses collectively, press [SHIFT], [MEMORY] (MEMORY SET key), numeric data key (start address), [.] (numeric data key (stop address)), and [kHz/ μ V] (CLEAR key) in this order.

The memory set mode is released when memory clear is completed.

Note: If an attempt is made to recall memory contents from addresses not associated with any data or operate the INCREMENT [\wedge] [\vee] or rotary knob in memory recall mode when all addresses are defined to be skipped, [STATUS] LED lights with no memory contents recalled. At this time, press [STATUS], and an error message is displayed on the display while the key is held down.



An erroneous setting is made in memory setting, [STATUS] LED lights. At this time, press [STATUS], and an error message is displayed on the display while the key is held down.

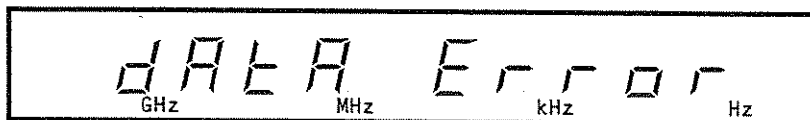

... Attempted to set memory addresses outside the designated range.

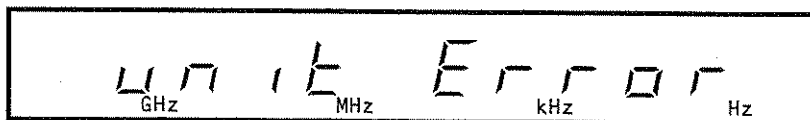

... Any key other than the unit key was pressed during or after numeric data entry.

4.5 Other Functions

The MG3631A/MG3632A is provided with two special function setting modes as shown below:

- **Shift key function:** Sets a special function which is rather frequently used. This type of function is set by pressing [SHIFT] and then the key displayed in blue characters.
- **Special function:** Sets a special function which is not normally used in manual operation. This type of function is set by entering 3-digit numeric code after pressing [SHIFT] and [0] (SPECIAL key).

4.5.1 Shift key function

This type of function is set by pressing [SHIFT] and then the key displayed in blue characters.

This section describes the shift key functions which are not described in paragraphs 4.1 to 4.4.

(1) Initialization

This function initializes the MG3631A/MG3632A.

To execute this function, press [STATUS] (INITIAL key) after pressing [SHIFT].

The following table lists the initial values of the MG3631A/MG3632A. (The initial settings can be altered using a special function).

Setting item	Initial settings
Setting mode	Frequency setting mode
Carrier frequency	1040 MHz
Frequency increment step value	1 MHz
Frequency resolution digit	10 Hz digit
Relative frequency mode	OFF
Frequency offset value	0 Hz
Knob increment	OFF
Output level	-30 dBm
Level increment step value	1 dB
Level resolution digit	0.1 dB digit
Voltage display mode	EMF (Open-circuit voltage display mode)
Continuous variable mode	OFF (Normal mode)
Relative level mode	OFF
Level offset value	0 dB
RF ON/OFF	ON
Knob increment	OFF

Setting item	Initial settings
FM modulation	OFF
Frequency deviation	3.5 kHz
Frequency deviation resolution digit	0.1 kHz digit
FM MAIN modulation signal	1 kHz
FM MIX modulation signal	OFF
FM MOD INPUT AC/DC	AC
FM MOD INPUT polarity	Not inverted
AM modulation	OFF
Modulation factor	30%
Modulation factor resolution digit	1% digit
AM MAIN modulation signal	1 kHz
AM MIX modulation signal	OFF
AM MOD INPUT AC/DC	AC
AM MOD INPUT polarity	Not inverted
AF frequency	1 kHz
AF frequency increment step value	100 Hz
AF frequency resolution digit	100 Hz digit
Knob increment	OFF
Memory contents	Status unchanged (No memory contents at any address at factory-shipment)
Memory skip settings	Status unchanged
Memory address	Minimum memory address that can be recalled
Bell	ON
Display	ON
GP-IB address	Status unchanged (03 at factory-shipment)
Special function	Status unchanged (see paragraph 4.5.2 for settings at factory-shipment)

(2) Bell ON/OFF

Sets bell sound ON or OFF that signals key operation or error occurrence.

To execute this function, press [SHIFT], then [1] (BELL key). When this function is executed, the bell sound is alternately turned ON and OFF.

(3) Display ON/OFF

This function sets all displays ON and OFF except POWER ON, STBY, and H and L LEDs.

To execute this function, press [SHIFT], then [2] (DISP key).

When this function is executed, the display is alternately turned ON and OFF.

(4) GP-IB address setting and display

This function sets a GP-IB address and displays the set value.

To execute this function, enter a GP-IB address in two digits using numeric keys after pressing [SHIFT] and [6] (ADRS key).

Hold down [6] (ADRS key) for 0.5 seconds or more after pressing [SHIFT], and the current set GP-IB address will be displayed on the FREQUENCY display while the key is held down.

Example: Set the GP-IB address to 07 and display the set value on display.

1. [SHIFT] [6]

Set the unit in GP-IB address input status.

2. [0] [7]

Enter a GP-IB address in two digits.

3. [SHIFT] [6]

The GP-IB address is displayed as shown below while [6] is held down.

↑
Hold down.

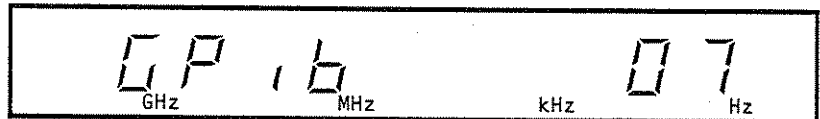

4.5.2 Special functions

These functions can be set by entering one of the 3-digit codes listed below after pressing [SHIFT] and [0] (SPECIAL key).

Special Functions List

Contents of special functions	Code
Complete initialization	000
* Initial setting memory: clear	111
Initial setting memory: store	112
-----	-----
Optional display	141
-----	-----
* GP-IB program code: normal	151
GP-IB program code: MG3633A compatible	152

* Special functions which are set when complete initialization is executed.

(1) Confirming the settings of special functions

To confirm the settings of special functions, press [STATUS] after pressing [SHIFT] and [0] (SPECIAL key). While [STATUS] is held down, the current set special function codes are sequentially displayed on the FREQUENCY display at intervals of about 1 second.

Key operation

[SHIFT] [0] [STATUS]
 ↑
 Hold down.

FREQUENCY display

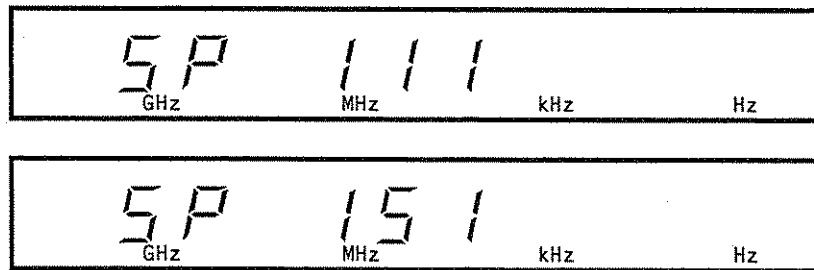

⋮

(2) Complete initialization (SPECIAL 000)

This function resets all internal status of the MG3631A/MG3632A to those set on shipment from the factory.

To execute this function, enter [0], [0], and [0] after pressing [SHIFT] and [0].

When this function is executed, the following is set:

- Special function codes 111 and 151.
- Normal initialization.
- Clear memory contents at all addresses.
- GP-IB address to 03.

(3) Initial setting memory: clear/store (SPECIAL 111/112)

This special function is used to change the panel conditions when normal initialization is performed ([SHIFT][STATUS]).

After making the panel conditions into a desired state, enter [1], [1], and [2] after pressing [SHIFT] and [0]. And the panel conditions at this time are stored in the initial setting memory. When initialization is executed using [SHIFT] and [STATUS], the contents of the initial setting memory are recalled.

To restore the initial set conditions as shown in paragraph 4.5.1 (1), enter [1], [1], and [1] after pressing [SHIFT] and [0] to clear the contents of the initial setting memory.

(4) Confirming optional installations (SPECIAL 141)

To confirm optional installations, enter [1], [4], and [1] after pressing [SHIFT] and [0]. While you hold down the last [1], the installed option codes are sequentially displayed on the FREQUENCY display at intervals of about 1 second. The installed option codes are displayed repeatedly as long as the key is held down.

Key operation

FREQUENCY display

[SHIFT] [0] [1] [4] [1]

↑
Hold down.

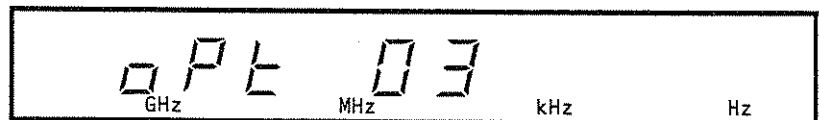

0.03
GHz MHz kHz Hz

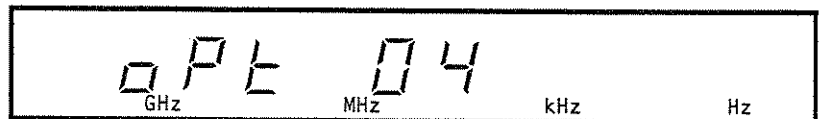

0.04
GHz MHz kHz Hz

⋮

(5) Converting GP-IB program code (SPECIAL 151/152)

The MG3631A/MG3632A can be controlled by using the GP-IB programs for other types of equipment listed below. At this time, use these functions to convert the GP-IB program code.

- MG3631A/MG3632A original (details described in paragraph 6.4) : [SHIFT][0] Δ [1][5][1]
- MG3633A (details described in paragraph 6.6) : [SHIFT][0] Δ [1][5][2]

Note: The MG3631A/MG3632A original uses the same basic commands as used for the MG3601A/MG3602A.

4.6 Status

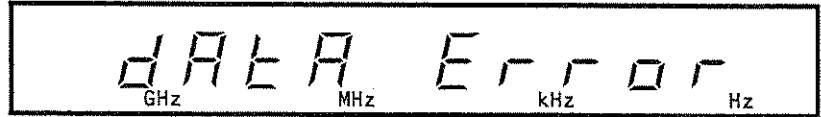
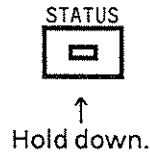

When an erroneous operation is committed with the MG3631A/MG3632A, [STATUS] LED lights. At this time, press [STATUS] and a status message is displayed on the FREQUENCY display while the key is held down.



The following table lists status messages and the contents of the messages.

Function	Contents	Message
All functions	Data error	DATA Error GHz MHz kHz Hz
	Unit error	unit Error GHz MHz kHz Hz
Modulation	Modulation setting error	Mod Error GHz MHz kHz Hz
Memory	Attempted to recall memory contents not stored.	no MEMORY GHz MHz kHz Hz
Special functions	Special functions not registered.	no SP code GHz MHz kHz Hz
Options	Attempted to set an uninstalled option.	no option GHz MHz kHz Hz

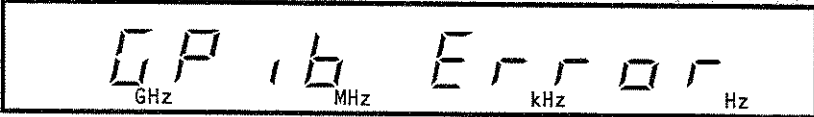
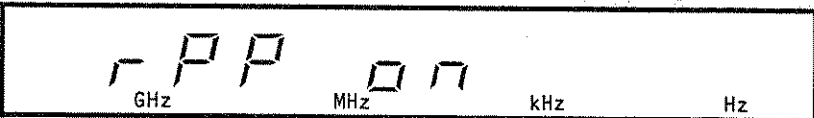
(Continued)

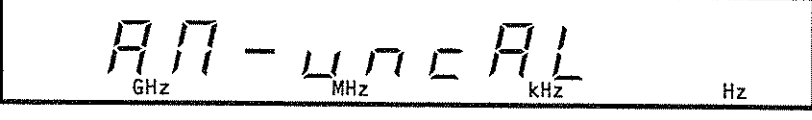
Function	Contents	Message
GP-IB	GP-IB read error	
Hardware	RPP operation	
UNCAL	Output level	
	FM	
	AM	
		When there are two or more occurrences of UNCAL, messages are displayed in order of the above each time [STATUS] is pressed.

4.6.1 Error status

If the input data or function setting is faulty, an error occurs and the unit is restored to the previous status without setting the data or function.

[STATUS] LED goes out when a message is displayed by pressing [STATUS] or any key other than the data and unit keys is pressed.

(1) Data error

- ① An error occurs when numeric data exceeds the predetermined number of digits.
 - Items displayed on the FREQUENCY display
 - Carrier frequency related: 10 digits
 - AF frequency related: 8 digits
 - Items displayed on the OUTPUT LEVEL display
 - Output level related: 3 digits
(Except 1, and sign in the first digit)
 - Items displayed on the MEMORY display
 - Memory address related: 2 digits
 - Items displayed on the MODULATION display
 - FM and AM modulation related: 3 digits
- ② An error occurs in the following cases when entering data.
 - [.] is pressed twice or more during data input.
 - [+/-] is pressed during AF frequency, AM modulation factor, FM frequency deviation, or memory address setting.
- ③ If an attempt is made to set a value outside the following data setting range, an error occurs when the unit key is pressed. The same error results when the setting range is exceeded during operation by the rotary knob or INCREMENT [^][v].

Item		Setting range		Conditions
		Lower limit	Upper limit	
Frequency	Carrier frequency	0 Hz	1040 MHz 2080 MHz	MG3631A MG3632A
	Increment step value	10 Hz	1040 MHz 2080 MHz	MG3631A MG3632A
	Offset value	-1040 MHz -2080 MHz	1040 MHz 2080 MHz	MG3631A MG3632A
Output level	Output level	-143 dBm -30 dB μ 0.032 μ V -36 dB μ 0.016 μ V	+13 dBm +126 dB μ 2 V +120 dB μ 1 V	} During open-circuit voltage display } } During terminal voltage display
	Increment step value	0.1 dB	156 dB	
	Offset value	-55 dB	55 dB	
AF frequency	AF frequency	0.1 Hz	100 kHz	
	Increment step value	0.1 Hz	100 kHz	
Modulation	FM frequency deviation	0 Hz	200 kHz	
	AM modulation factor	0%	100%	
Memory address		0	99	
GP-IB address		0	30	

(2) Unit error

An error occurs if an inappropriate unit key is pressed during or after entering numeric data.

The following table lists the appropriate unit keys for each setting item.

Item		Unit key			
		[GHz/dBm] (dB, RECALL)	[MHz/dB μ] (STORE)	[kHz/mV] (%, SKIP)	[Hz/ μ V] (CLEAR)
Frequency	Carrier frequency	○	○	○	○
	Increment step value	○	○	○	○
	Offset value	○	○	○	○
Output level	Output level	○	○	○	○
	Increment step value	○	×	×	×
	Offset value	○	×	×	×
AF	AF frequency	○	○	○	○
	Increment step value	○	○	○	○
Modulation	FM frequency deviation	×	○	○	○
	AM modulation factor	×	×	○	×
Memory	Recall mode	○	×	○	×
	Set mode	×	○	○	○

○ : Appropriate

× : Inappropriate

(3) Modulation error

When an attempt is made to set the modulation factor or frequency deviation of a MIX modulation signal while the modulation function or the MIX modulation signal is OFF, the attempted setting is not accepted and an error occurs.

4.6.2 UNCAL status

UNCAL indicates a status where a setting although within the setting range, exceeds the performance-guaranteed range.

[STATUS] LED remains ON as long as a setting is made in the UNCAL area.

(1) UNCAL area of output level

① During normal mode

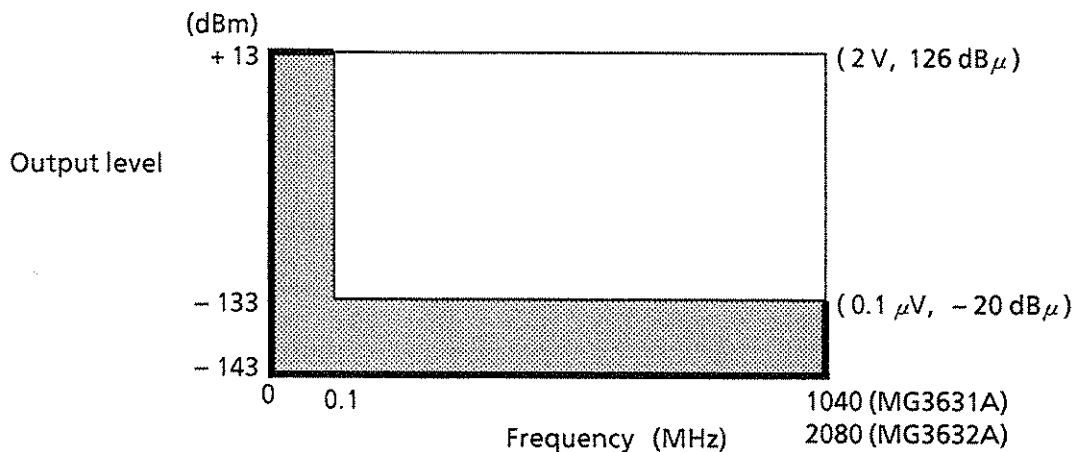

② During continuous variable mode

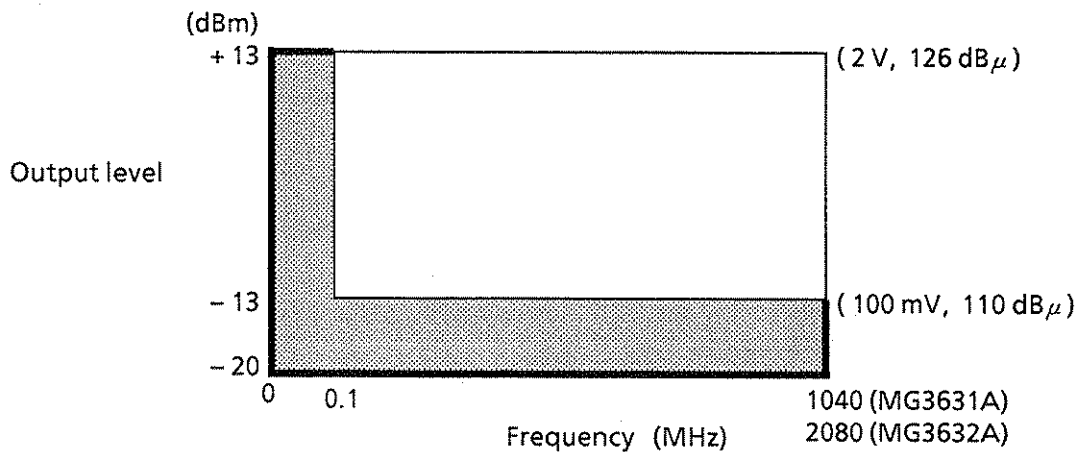

- : UNCAL area
- : Included in UNCAL area
- : Not included in UNCAL area

(2) UNCAL area of FM frequency deviation (MAIN + MIX)

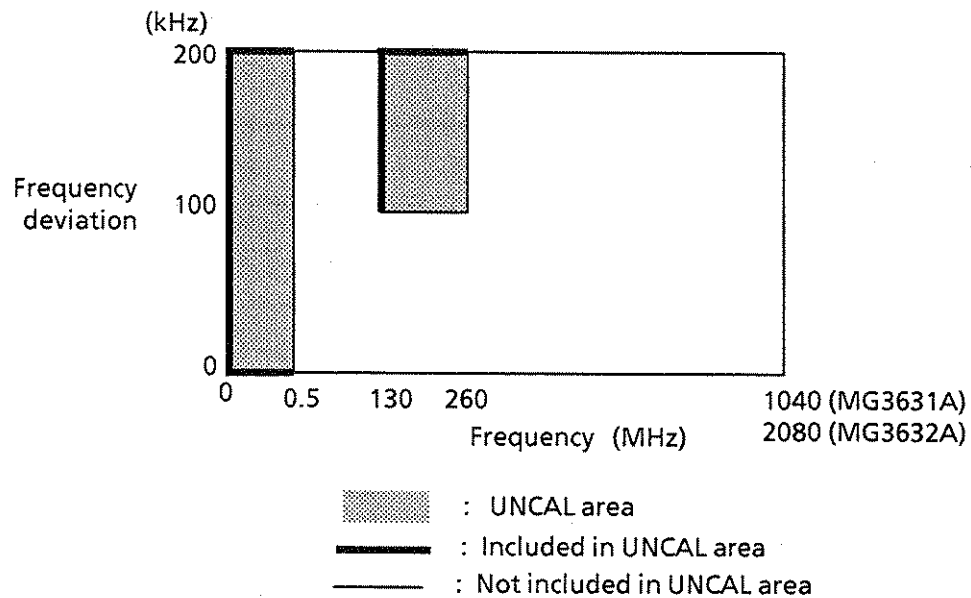

(3) UNCAL area of AM modulation factor (MAIN + MIX)

AM UNCAL occurs if any one of the following (1) to (3) is in the UNCAL area.

① AM modulation factor

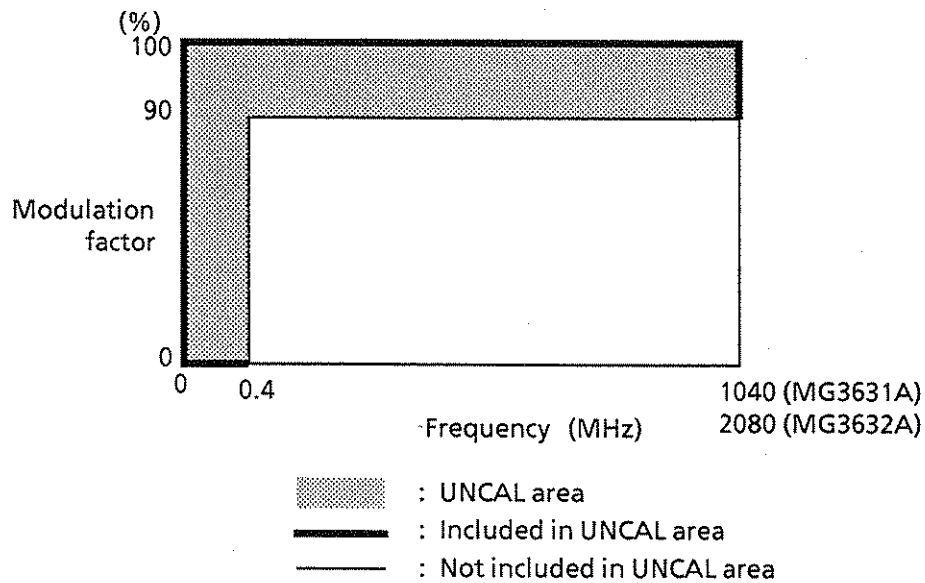

② Output level (during normal mode)

When exceeding +7 dBm.

③ ALC attenuator output level (during continuous variable mode)

When exceeding +7 dBm or less than 0 dBm.

4.7 Message Display by 7-Segment Display

The MG3631A/MG3632A uses a 7-segment display to display various messages. For this reason, some characters may not be easily legible. The following table lists the numbers and alphabets as displayed by the 7-segment display.

0	1	2	3	4	5	6	7	8	9	A	B
0	1	2	3	4	5	6	7	8	9	A	b

C	D	E	F	G	H	I	J	K	L	M	N
c	d	E	F	G	h	i	J	H	L	M	n

O	P	Q	R	S	T	U	V	W	X	Y	Z
o	P	q	r	S	t	u	v	W	11	y	z

SECTION 5

MEASUREMENT

In this section it is explained - through the use of typical measurement situations - how receiver sensitivity and selectivity can be evaluated using the MG3631A/MG3632A Synthesized Signal Generator (SG).

For all the procedures described in this section, the MG3631A/MG3632A is assumed to be in an initial powered-up setting.

5.1 Measuring Sensitivity

The sensitivity of a receiver is the minimum signal input level required to obtain the rated signal output. At this time, the signal level, noise level, and signal distortion of the receiver output are handled as follows:

(1) AM receiver

Sensitivity is defined as the minimum standard modulated carrier voltage required to obtain the rated signal output at the specified S/N ratio.

For example, the minimum 60%-modulated carrier input voltage required to obtain a 50 mW signal output with a 20 dB S/N, is 10 μ V.

(2) FM receiver

Sensitivity is defined as the minimum standard deviated carrier voltage required to obtain the rated output at the specified S/N ratio and distortion (SINAD) (for example, -12 dB SINAD for the 400 MHz band). In addition, another measure of sensitivity is the minimum carrier voltage required to suppress receiver noise output by 20 dB when no signal is being received. This is called the 20 dB noise quieting (NQ) sensitivity.

This paragraph explains how to measure the 20 dB NQ sensitivity and 12 dB SINAD sensitivity.

5.1.1 Measuring 20 dB NQ sensitivity

The 20 dB noise quieting (NQ) sensitivity is the minimum carrier input voltage required to suppress the receiver noise output by 20 dB when no signal is being input. Obtain the noise output before suppression by using the volume controller of the low-frequency amplification stage of the receiver so that the rated signal output can be obtained.

(1) Setup

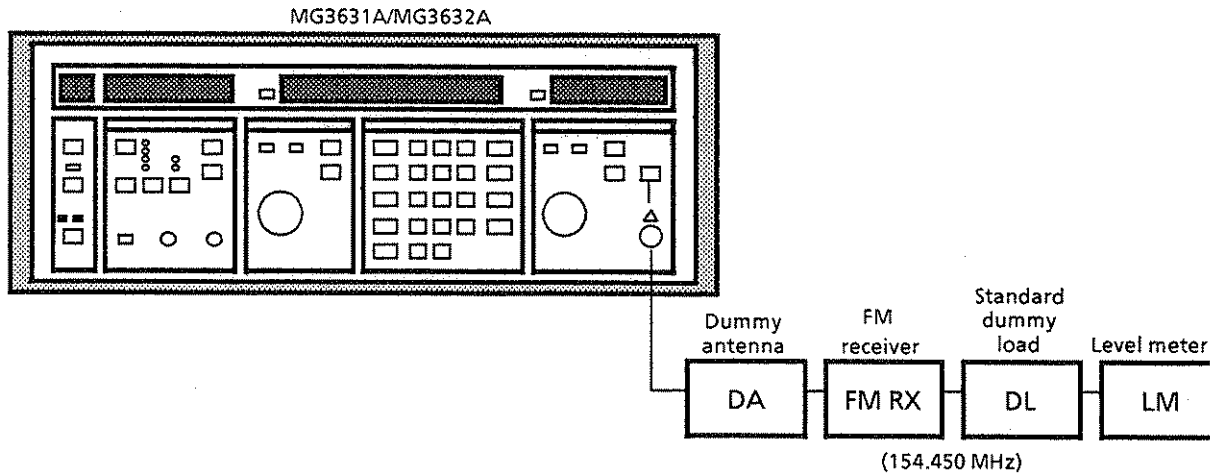

Fig. 5-1 20 dB NQ Sensitivity Measurement

(2) Measurement procedures

Step	Procedure
1	Set the MG3631A/MG3632A to 154.45 MHz.
2	Set the frequency deviation of the MG3631A/MG3632A to 70% of the specified maximum frequency deviation. If the specified maximum frequency deviation is 5 kHz, for example, set the frequency deviation of the SG to 3.5 kHz. Also, set the internal modulation frequency to 1 kHz.
3	Set the MG3631A/MG3632A output to an adequate level (30 dB μ or more), then supply the signal to the receiver.
4	Tune the receiver to 154.45 MHz (so that level meter (LM) deflection is maximum). Adjust the volume controller of the low-frequency amplification stage of the receiver so that the rated output can be obtained from the receiver according to the LM indication.
5	Turn the MG3631A/MG3632A output OFF. Also, turn the squelch of the receiver OFF.
6	Use LM to measure the noise output of the receiver, and set the meter indication to 0 dB.

Step	Procedure
7	Set MG3631A/MG3632A modulation to OFF. Set MG3631A/MG3632A output to ON.
8	Operate the INCREMENT [∧] [∨] and rotary knob in the MG3631A/MG3632A to adjust output level so that the LM indicates -20 dB. The value read on the OUTPUT LEVEL display of the MG3631A/MG3632A is the 20 dB NQ sensitivity.

5.1.2 Measuring 12 dB SINAD sensitivity

SINAD sensitivity is defined as the maximum SG output level at which the distortion does not exceed a specified standard (In Japan it is -12 dB for the 400 MHz band). The SINAD is determined by reducing SG output from a maximum level - while measuring distortion - until the demodulated receiver output of the standard modulation signal meets the distortion specification.

(1) Setup

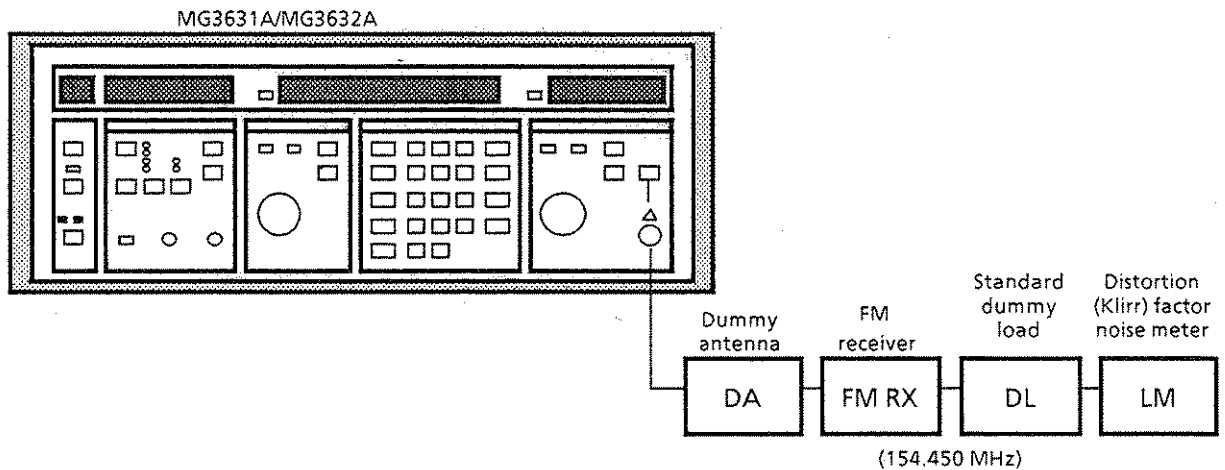

Fig. 5-2 12 dB SINAD Sensitivity Measurement

(2) Measurement procedures

Step	Procedure
1	Set the MG3631A/MG3632A to 465.05 MHz as shown below.
2	Set the MG3631A/MG3632A to 70% of the specified maximum frequency deviation. If the specified maximum frequency deviation is 5 kHz, for example, set the MG3631A/MG3632A to 3.5 kHz. Also, set the internal modulation frequency to 1 kHz.
3	Set the MG3631A/MG3632A output to an adequate level (30 dB μ or more), then supply it to the receiver.
4	Turn receiver squelch OFF, then tune the receiver to receive a frequency of 465.05 MHz (so that KNM deflection is maximized). Adjust receiver volume controller of the low frequency amplification stage so that the rated receiver output can be obtained according to the KNM indication.
5	Operate the INCREMENT [\wedge] [\vee] and rotary knob of the MG3631A/MG3632A to adjust output level so that the SINAD indication value of the KNM is -12 dB. The value read on the OUTPUT LEVEL display of the MG3631A/MG3632A is the 12 dB SINAD sensitivity.

5.2 Measuring One-Signal Selectivity

One-signal selectivity measurements are performed when both the desired and undesired signals are weak and when the receiver will operate in the linear range of the amplifier. When the SG signal is inputting to the receiver, selectivity is measured as the voltage ratio (desired/undesired) necessary to produce equivalent receiver outputs when the SG signal is alternated between desired and undesired signals. In this selectivity measurement, the pass band-width, attenuation, and spurious response are measured.

5.2.1 Using 20 dB NQ method to measure FM receiver selectivity

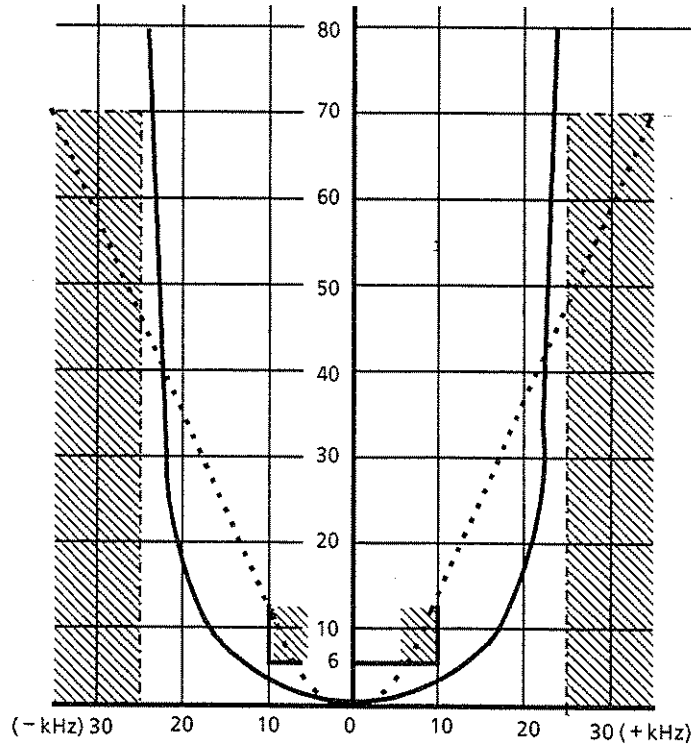

The figure on the left shows the selectivity characteristics of the 146 to 162 MHz band single-channel receiver. The specifications are as follows:

- **Pass bandwidth:**
The width of 6 dB selectivity is 20 kHz (± 10 kHz) or more.
- **Attenuation:**
The width of 70 dB selectivity is 50 kHz (± 25 kHz) or less.

Therefore, using the 20 dB NQ method, these selectivity are measured as follows:

- **Pass bandwidth:**
Obtained from the frequency width obtained by increasing the SG output level to 6 dB higher than the 20 dB NQ sensitivity, and adjusting the SG frequency so that the receiver output will be the same as the 20 dB NQ level again.
- **Attenuation:**
Obtained in the same way as above except for increasing the SG output level by 70 dB instead of 6 dB.

* Curve must not overlap the shaded region. Solid-line curve is acceptable, the dashed-line curve is unacceptable.

(1) Setup

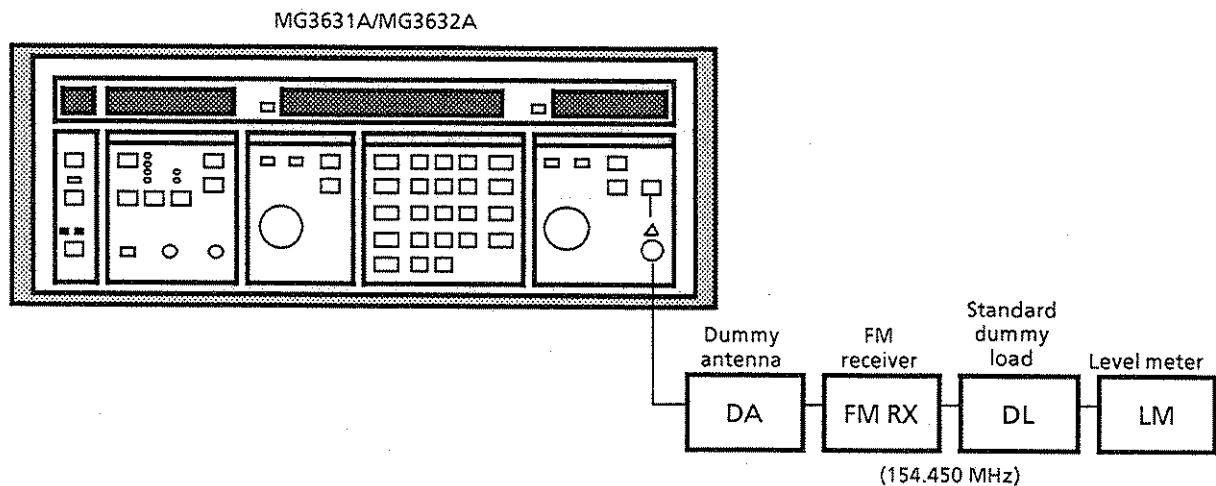

Fig. 5-3 Using 20 dB NQ Method to Measure Selectivity

(2) Measurement procedures 1 -- Pass bandwidth

Step	Procedure
1	Set the frequency and output level of the MG3631A/MG3632A, and FM RX in the same way as in 20 dB NQ sensitivity measurement (see paragraph 5.1.1).
2	Set the MG3631A/MG3632A to the relative level mode; set the output level resolution to 1 dB.
3	Turn the rotary knob clockwise to increase the output level of the MG3631A/MG3632A to 6 dB higher than the 20 dB NQ sensitivity.
4	Set the MG3631A/MG3632A output frequency resolution to 100 Hz.
5	Turn the rotary knob counterclockwise to lower the frequency and obtain a value where the 20 dB NQ level is indicated on the LM again.
6	Set the MG3631A/MG3632A to the relative frequency mode.
7	Turn the rotary knob clockwise to increase the frequency and obtain the frequency where the 20 dB NQ level is indicated on the LM again. The value on the MG3631A/MG3632A FREQUENCY display is the pass bandwidth.

(3) Measurement procedures 2 -- Attenuation

Step	Procedure
1	Set the frequency and output level of the MG3631A/MG3632A, and FM RX in the same way as in the 20 dB NQ sensitivity measurement (see paragraph 5.1.1).
2	Set the MG3631A/MG3632A to relative level mode; set output level resolution to 10 dB.
3	Turn the rotary knob clockwise to increase the output level of the MG3631A/MG3632A to 70 dB higher than the 20 dB NQ sensitivity.
4	Set the MG3631A/MG3632A output frequency resolution to 100 Hz.
5	Turn the rotary knob counterclockwise to lower the frequency and obtain the frequency where the 20 dB NQ level is indicated on the LM again.
6	Set the MG3631A/MG3632A to the relative frequency mode.
7	Turn the rotary knob clockwise to increase the frequency and obtain the frequency where the 20 dB NQ level is indicated on the LM again. The value on the MG3631A/MG3632A FREQUENCY display is the 70 dB attenuation bandwidth.

5.2.2 Measuring spurious response

Spurious sensitivity is low when there is a large difference between receiver output derived from source signals of a desired modulated signal compared with that from an undesired modulated signal source of spurious frequency. To measure the spurious response, adjust SG spurious frequency output so that both receiver outputs are equivalent. The difference between the SG spurious and desired output levels is the spurious sensitivity.

Assuming the desired signal frequency to be f_d , receiver IF frequency to be f_i , and receiver local frequency to be f_L , the spurious frequency f_s is:

- Image frequency interference

$$f_s = f_L \pm f_i = f_d \pm 2f_i$$

- Harmonic interference:

$$f_s = f_L \pm f_i/2, f_s = nf_d \pm f_i/2$$

When a signal is received that causes the frequency difference from the receiver local frequency to be $f_i/2$, the second harmonic of $f_i/2$ component becomes the IF frequency and interference occurs.

- Local frequency harmonic interference:

$$f_s = nf_L \pm f_i$$

An example for $f_d = 154.450$ MHz, $f_s = f_d + 2f_i$, and $f_i = 10.7$ MHz is given here.

(1) Setup

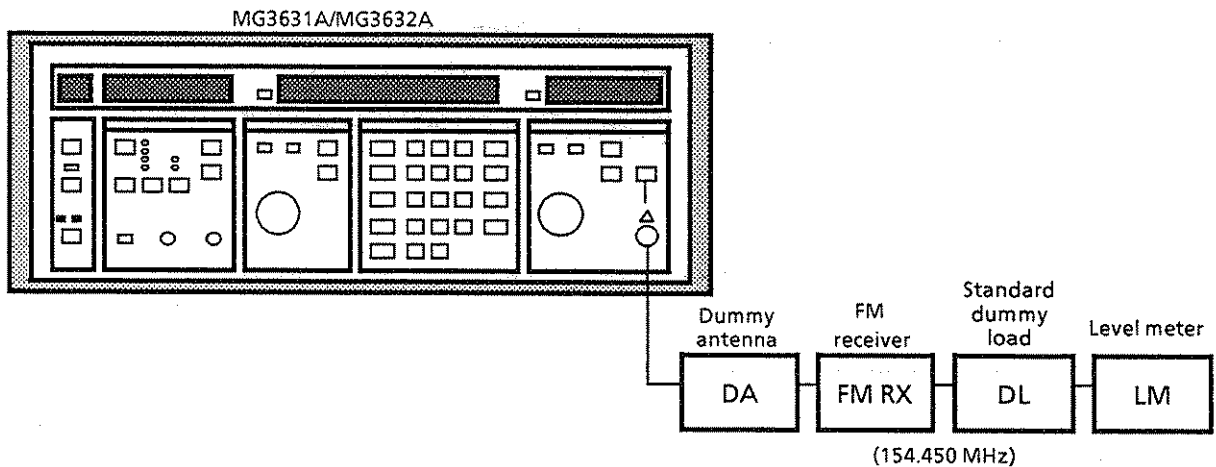

Fig. 5-4 Spurious Sensitivity Measurement

(2) Measurement procedures

Step	Procedure
1	Set the MG3631A/MG3632A to the desired frequency $f_d = 154.45$ MHz.
2	Set the frequency deviation of the MG3631A/MG3632A to 70% of the specified maximum frequency deviation. If the specified maximum frequency deviation is 5 kHz, for example, set the frequency deviation of the MG3631A/MG3632A to 3.5 kHz. Also, set the internal modulation frequency to 1 kHz.
3	Set the output level of the MG3631A/MG3632A high enough (usually, to -83 dBm [$= 30$ dB μ] or more), then input it to the receiver.
4	Turn receiver squelch OFF, and then tune the receiver to receive the 154.45 MHz signal (so LM deflection is maximum). Adjust the volume control for low frequency amplification (at the first stage, if possible) so that the rated output level can be obtained from the receiver according to the LM indication.
5	Set the MG3631A/MG3632A to the relative frequency mode.
6	Input spurious frequency ($f_s = f_d + 2f_i$) signal from the MG3631A/MG3632A to the receiver while keeping the receiver setting condition and the MG3631A/MG3632A modulation frequency and frequency deviation as is. For changing the MG3631A/MG3632A frequency to the spurious frequency, set $2 \times f_i = 2 \times 10.7$ MHz in the relative frequency mode.
7	Set the MG3631A/MG3632A to the relative level mode.
8	Set the MG3631A/MG3632A output level resolution to 1 dB.
9	Operate the INCREMENT [∇] [\wedge] and rotary knob of the MG3631A/MG3632A to adjust the output level so that the LM indicates the same value as the rated output in step 4. The value on the MG3631A/MG3632A OUTPUT LEVEL display is the spurious sensitivity.

5.3 Measuring Two-Signal Selectivity

In the one-signal selectivity measurements, the input signal level must be changed from around 0 dB μ up to around 100 dB μ to measure selectivity using a fixed output level receiver.

Because of the necessary large changes in SG output level, it is difficult for receiver amplifiers to produce a linear response over the entire range. Usually, amplifiers response is linear over an range of 20 or 30 dB. For a larger changes, however, sensitivity for high-level input diminishes due to saturation of the amplifier, among other factors, which causes errors in the measurement values.

Two-signal selectivity (or effective selectivity) measurement is more suited to actual receiver conditions. This selectivity can indicate the interference separation capability of the receiver. That is, it indicates the maximum allowable input level of the undesired signal for suppressing the interference signal in the receiver output down to a fixed value while still maintaining reception of the desired signal. The following items are included.

1. Blocking effect
2. Cross-modulation characteristics
3. Inter-modulation characteristics

Items 1 and 2 above are explained in this section.

5.3.1 Measuring blocking effect of FM receiver

The blocking effect is characterized by the relationship of frequency separation (Δf) between desired and undesired non-modulated input signals on the same receiver output noise. Below, a graph shows the typical relationship between Δf and the input level for the undesired signal when the receiver output level is kept constant and the desired signal input is maintained at 6 dB higher than the 20 dB NQ sensitivity level. As is expected, as Δf becomes small, the level of the undesired signal input must be drastically reduced to maintain the same receiver output noise level.

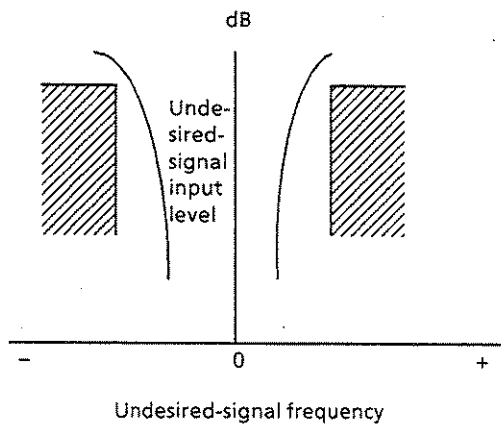

The following example is a measurement where the desired signal is 154.450 MHz and the undesired signal is $\pm 20 \text{ kHz} \times n$ apart from the desired signal.

(1) Setup

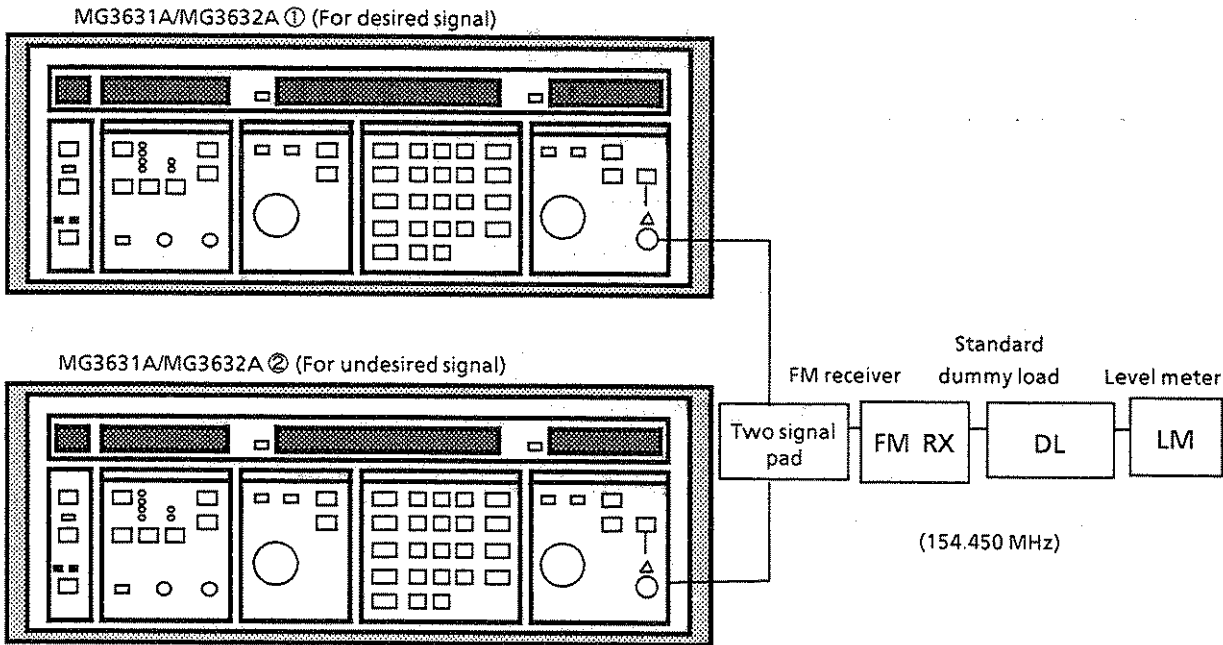

Fig. 5-5 Two-signal Selectivity Measurement

(2) Measurement procedures

Step	Procedure
1	Set the MG3631A/MG3632A ② output to OFF.
2	Set the frequency and output level of the MG3631A/MG3632A ①, and FM RX in the same way as in 20 dB NQ sensitivity (see paragraph 5.1.1). Assume the noise level to be V_N dB at this time.
3	Set the MG3631A/MG3632A ① output to OFF. Set the frequency and output level of the MG3631A/MG3632A ②, and FM RX in the same way as in 20 dB NQ sensitivity. (the noise level is V_N dB at this time.)
4	Set the MG3631A/MG3632A ② output to OFF and the MG3631A/MG3632A ① output to ON again.
5	Set the MG3631A/MG3632A ① to the relative level mode. Set the output level resolution to 1 dB.
6	Turn the rotary knob of the MG3631A/MG3632A ① clockwise to increase the output level by 6 dB higher than the 20 dB NQ sensitivity.
7	Hold the MG3631A/MG3632A ① in the status of step 6. Set the MG3631A/MG3632A ② output to ON.

Step	Procedure
8	Set the MG3631A/MG3632A ② to the relative level mode and set the output level resolution to 1 dB.
9	Set the increment frequency ΔF of the MG3631A/MG3632A ② to 20 kHz.
10	Adjust the rotary knob of the MG3631A/MG3632A ② to increase the output level so that the noise output of the receiver is V_N dB in step 2, each time the INCREMENT [^] is pressed. At this time, the value indicated by the OUTPUT LEVEL display of MG3631A/MG3632A ② is the undesired signal input level (dB) separated by $\Delta F \times n$ from the desired signal.
11	Reset MG3631A/MG3632A ② to the desired signal frequency of 154.450 MHz. (The same frequency as in steps 2 and 3.) Also, reset the MG3631A/MG3632A ② output level to the level at the time when the relative level mode was set in step 8.
12	Adjust the rotary knob of the MG3631A/MG3632A ② to increase the output level so that the noise output level of the receiver is V_N dB in step 2, each time the INCREMENT [v] is pressed. At this time, the value indicated by the OUTPUT LEVEL display of MG3631A/MG3632A ② is the undesired signal input level (dB) separated by $-\Delta F \times n$ from the desired signal.

From steps 10 and 12, the following blocking characteristics are obtained.

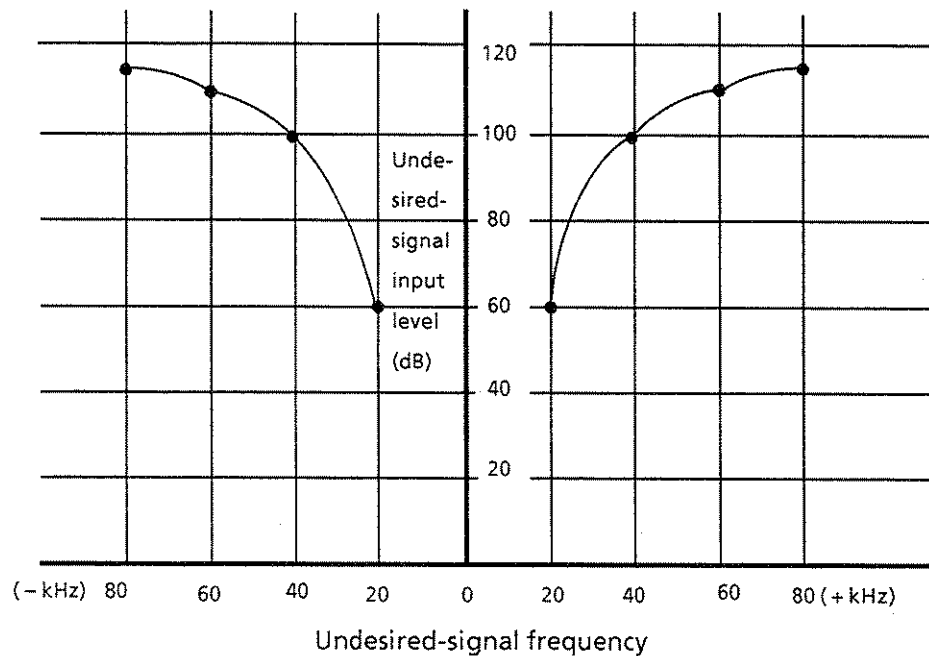

5.3.2 Measuring cross-modulation characteristics

Cross-modulation is evaluated in terms of the effect of an undesired modulated signal on the receiver output with a separate non-modulated desired signal. When the undesired and desired signals are close in frequency, demodulated signal appears at the receiver output. The cross-modulation is indicated by the undesired modulated input level when the receiver output level is a level lower than the rated output level by a specified amount. The rated output is obtained when a modulated signal is output free of interference.

When a relatively high-level modulated undesired signal is received with an non-modulated desired signal, non-linear operation of the receiver results in modulation of the desired signal, a phenomena known as cross modulation.

(1) Setup

Figure 5-5 in paragraph 5.3.1 shows the required setup. Measuring AM signal is explained.

In the measurement procedure below, it is assumed that the desired signal is 1500 kHz and that the undesired signal is $\pm 5 \text{ kHz} \times n$ apart from the desired signal.

(2) Measurement procedures

Step	Procedure
1	Set the MG3631A/MG3632A ② output (for undesired signal) to OFF.
2	Set the MG3631A/MG3632A ① frequency (for the desired signal) to 1500 kHz.
3	Set the AM modulation factor of the MG3631A/MG3632A ① to 30% and the internal modulation frequency to 400 Hz.
4	Tune the receiver to 1500 kHz (so LM deflection is maximum). Set the AGC of the receiver to OFF and adjust the receiver to optimum status.
5	Operate the INCREMENT [V] [^] and rotary knob of the MG3631A/MG3632A ① to adjust output level so that the LM indicates the rated signal output.
6	Assume the value of the MG3631A/MG3632A ① OUTPUT LEVEL display in step 5 to be $E_1 \text{ dB}\mu$.
7	Set the MG3631A/MG3632A ① modulation to OFF. Set the MG3631A/MG3632A ② output to ON.
8	Set the MG3631A/MG3632A ② to 1500 kHz.

Step	Procedure
9	Set the MG3631A/MG3632A ② output level so that it is the same as the MG3631A/MG3632A ① output level (E_1 dB μ) in step 6.
10	Set the modulation factor and modulation frequency of the MG3631A/MG3632A ② to 30% and 400 Hz, respectively, in the same way as for the MG3631A/MG3632A ① in step 3.
11	Operate the rotary knob of the MG3631A/MG3632A ② to adjust output level so that the receiver output is 20 dB less than the rated signal output in step 5 (this is the cross-modulation characteristic when the undesired signal frequency is the same as the desired signal frequency). Assume the output level of the MG3631A/MG3632A ② at that time is E_2 dB μ . Assume the level 20 dB (1/10) less than the rated output is V_S dB.
12	Set the MG3631A/MG3632A ② to the relative frequency and relative level modes, and set the output level resolution to 1 dB.
13	Set increment step frequency ΔF of the MG3631A/MG3632A ② to 5 kHz.
14	Adjust the rotary knob of the MG3631A/MG3632A ② to increase the output level so that the noise output level of the receiver is V_S dB in step 11, each time the INCREMENT [\wedge] is pressed. At this time, the value indicated by the OUTPUT LEVEL display of MG3631A/MG3632A ② is the undesired-signal input level (dB) at $\Delta F \times n$ apart from the desired signal.
15	Reset the MG3631A/MG3632A ② frequency to the desired-signal frequency 1500 kHz. Also, reset the MG3631A/MG3632A ② output level to the level at the time when the relative level mode was set in step 12.

Step	Procedure
------	-----------

- 16 Adjust the rotary knob of the MG3631A/MG3632A ② to increase the output level so that the noise output level of the receiver is V_S dB in step 11, each time INCREMENT [V] is pressed.

At this time, the value indicated by the OUTPUT LEVEL display of MG3631A/MG3632A ② is the undesired-signal input level (dB) at $-\Delta F \times n$ apart from the desired signal.

From steps 14 and 16, the following selectivity characteristic for cross-modulation are obtained.

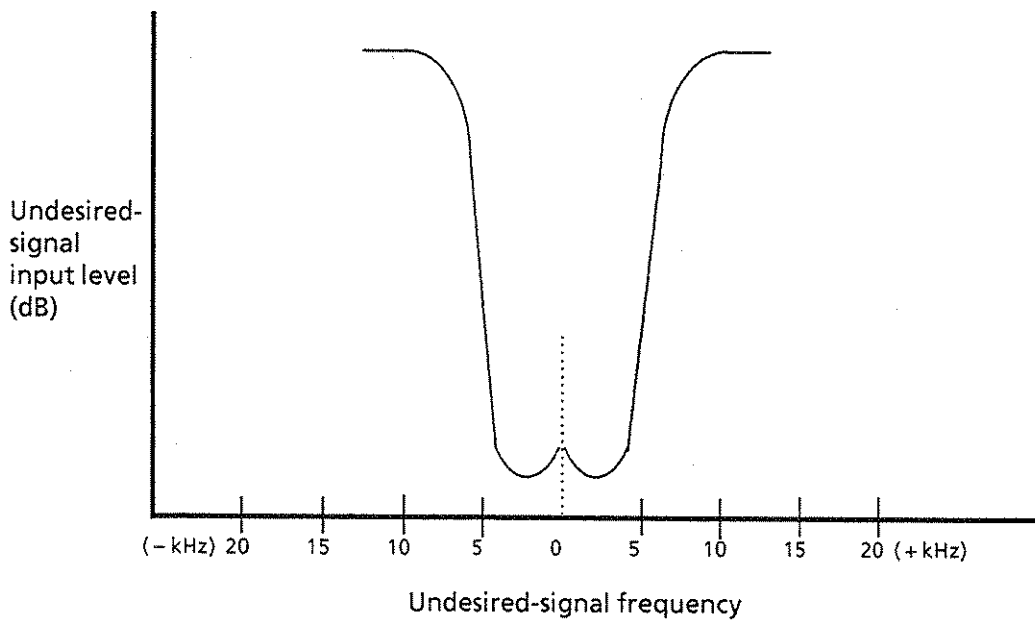

SECTION 6

GP-IB

6.1 Introduction

This paragraph describes the outline and specifications (interface function and device messages) of the GP-IB remote control.

6.1.1 Outline

The MG3631A/MG3632A Synthesized Signal Generator is equipped with a General Purpose Interface Bus (GP-IB) interface as standard. The GP-IB is an interface bus for measurements performed in accordance with Institute of Electrical and Electronic Engineers (IEEE-488) or International Electrotechnical Commission (IEC-625) standards.

The MG3631A/MG3632A has the following GP-IB functions.

1. Control of all functions except for POWER switch and [LOCAL]
2. Sets the GP-IB address with the panel keys
3. Displays the GP-IB address on the FREQUENCY display
4. Configures and automatic measuring system by combining the MG3631A/MG3632A with a personal computer and other measuring instruments

The GP-IB used in the MG3631A/MG3632A conforms to the IEEE-488.1 version (not to the IEEE-488.2 version).

Explanations in this operation manual are based on program examples using the NEC (Japan) PC9800-series Personal Computer

6.1 2 Specifications

(1) GP-IB Interface Functions

The following table lists GP-IB interface functions for the MG3631A/MG3632A.

GP-IB Interface Functions

Symbol	Interface function	Remarks
SH0	All source handshake functions not provided	_____
AH1	All accept handshake functions provided	Data receivable
T0	Talker function not provided	_____
L4	Basic listener function provided Listen only function not provided Listener release function by MTA provided	Listener function provided
TE0	Address extension talker function not provided	No listener provided with function to extend up to secondary address
LE0	Address extension listener function not provided	
SR0	Service request functions not provided	_____
RL1	All remote/local functions provided	Local lockout function provided
PP0	Parallel polling function not provided	_____
DC1	All device clear function provided	All functions made initial condition
DT0	Device trigger function not provided	_____
C0	Control function not provided	Control function not provided
E2	Tri-state driver	_____

Note: The MG3631A/MG3632A has not the talker function, so the GP-IB device messages consist of the control messages, only.

(2) Device Messages

The MG3631A/MG3632A device messages (consist of control messages only) are listed on a table in the following pages:

GP-IB Program Code

Item	Parameter	Program code
Data	NUMERAL 0 ~ 9 MINUS DECIMAL POINT	0~ 9 - .
Unit	dB dBm dB μ V mV μ V GHz MHz kHz Hz %	DB DBM DBU V MV UV GHZ MHZ KHZ HZ PC
Frequency	FREQUENCY FREQUENCY INCREMENTAL STEP VALUE FREQ INCREMENTAL STEP UP FREQ INCREMENTAL STEP DOWN FREQ KNOB UP FREQ KNOB DOWN FREQ RESOLUTION 10Hz FREQ RESOLUTION 100Hz FREQ RESOLUTION 1kHz FREQ RESOLUTION 10kHz FREQ RESOLUTION 100kHz FREQ RESOLUTION 1MHz FREQ RESOLUTION 10MHz FREQ RELATIVE OFF FREQ RELATIVE ON FREQ OFFSET	FR DF IU ID FU FD R1 R2 R3 R4 R5 R6 R7 F0 F1 F0

GP-IB Program Code (Continued)

Item	Parameter	Program code
Output level	LEVEL LEVEL INCREMENTAL STEP VALUE LEVEL INCREMENTAL STEP UP LEVEL INCREMENTAL STEP DOWN LEVEL KNOB UP LEVEL KNOB DOWN LEVEL RESOLUTION 0.1dB (1st digit) LEVEL RESOLUTION 1dB (2nd digit) LEVEL RESOLUTION 10dB (3rd digit) LEVEL CONTINUOUS MODE OFF LEVEL CONTINUOUS MODE ON LEVEL RELATIVE OFF LEVEL RELATIVE ON RF OFF RF ON LEVEL OFFSET LEVEL UNIT CHANGE to dBm LEVEL UNIT CHANGE to dB μ LEVEL UNIT CHANGE to V or mV or μ V OPEN-CIRCUIT VOLTAGE DISPLAY (EMF) TERMINATED VOLTAGE DISPLAY RPP RESET	OL DL LIU LID LU LD L2 L3 L4 C0 C1 L0 L1 RF FO LO OLDBM OLDBU OLV SP03 SP04 RF
FM/AM modulation	FM DEVIATION (MAIN SOURCE) FM DEVIATION (MIX SOURCE) FM ON FM OFF AM DEPTH (MAIN SOURCE) AM DEPTH (MIX SOURCE) AM ON AM OFF MOD MAIN SOURCE 1kHz MOD MAIN SOURCE 400Hz MOD MAIN SOURCE AF MOD MAIN SOURCE EXT MOD MIX SOURCE OFF MOD MIX SOURCE AF MOD MIX SOURCE EXT	FM FMM FMO FMF AM AMM AMO AMF M1 M3 M5 M7 SM0 FM5 SM7

GP-IB Program Code (Continued)

Item	Parameter	Program code
Modulation degree	MOD STEP UP	MU
	MOD STEP DOWN	MD
	MOD RESOLUTION 1st digit	S1
	MOD RESOLUTION 2nd digit	S2
	MOD RESOLUTION 3rd digit	S3
AF frequency	AF (AUDIO FREQUENCY)	AF
	AF INCREMENTAL STEP	DA
	AF INCREMENTAL STEP UP	AIU
	AF INCREMENTAL STEP DOWN	AID
	AF KNOB UP	AU
	AF KNOB DOWN	AD
	AF RESOLUTION 0.1Hz	A1
	AF RESOLUTION 1Hz	A2
	AF RESOLUTION 10Hz	A3
	AF RESOLUTION 100Hz	A4
	AF RESOLUTION 1kHz	A5
	AF RESOLUTION 10kHz	A6
EXT input	AC COUPLE	EXA
	DC COUPLE	EXD
	POLARITY NORMAL	EXN
	POLARITY INVERT	EXI
Memory	MEMORY	FN
	RECALL	RL
	STORE	ST
	SKIP	SK
	SKIP RESET	SC
	CLEAR	CL
	ADDRESS UP	ADU
	ADDRESS DOWN	ADD

GP-IB Program Code (Continued)

Item	Parameter	Program code
Others	INITIAL SET BELL OFF BELL ON DISPLAY OFF DISPLAY ON	SP00 SP01 SP02 D0 D1

6.2 GP-IB Address

This paragraph explains the GP-IB cable connection and the GP-IB address setting/changing.

6.2.1 Precautions before using GP-IB

(1) Connecting and disconnecting GP-IB cable

Connect and disconnect the GP-IB cable with the POWER switch set to OFF and with the power cord pulled out.

The reason is described below. Occasionally, the common signal line of the cable may be disconnected faster than the other lines when connecting and disconnecting the cable. At this time, if the power is left on, parts such as ICs in the interface unit may be damaged as a result of AC leak voltage.

(2) Setting and confirming GP-IB address

Set the GP-IB address after turning on the power with front panel keys.

Address No. 03 is set at the factory so it is not necessary to set the address when 03 is to be used.

Set the GP-IB address as follows:

- After the power is turned on, set the local state and input GP-IB address.
- When the remote state (REMS) is set, press [LOCAL] to set the local state.
- When the remote with lockout state (RWLS) is set, obtain the local state by executing program.

Note: When the power is turned ON; the device on the GP-IB becomes the local state in general.

(a) Confirming address

Press [SHIFT] and then [6] ([ARDS]) (hold [6] for more than 0.5 s). The current address is displayed on the FREQUENCY display while [6] is pressed.

(b) Setting address

- Press [SHIFT] and [6] ([ARDS]), then set the address by using the numeric keys [0] to [9].
- Set the address by using two-digit numeric. Addresses 0 (00) to 9 (09) are set by pressing [0] [0] to [0] [9].
- Address setting range: 00 through 30
- Set address is backed-up in a memory.

Example: Set remote status (REMS) to local status, check the current address 13, then change the address to 6.

Step	Key Operation	Verification
1	[LOCAL]	Check REMOTE lamp went out.
<u>Confirming address</u>		
2	[SHIFT] [6] ↑ Press and hold.	
<u>Changing address</u>		
3	[SHIFT] [6]	Goes to the GP-IB address inputtable state.
4	[0] [6]	GP-IB address becomes 06.

6.3 Device-Message General Format

As indicated with the figure below, the general structure of a device message is in three parts: header HR, data NR, and separator SR, in this order.

Also indicated is that any one of the header, numeric data, or separator fields can be omitted, and the data element may be repeated.

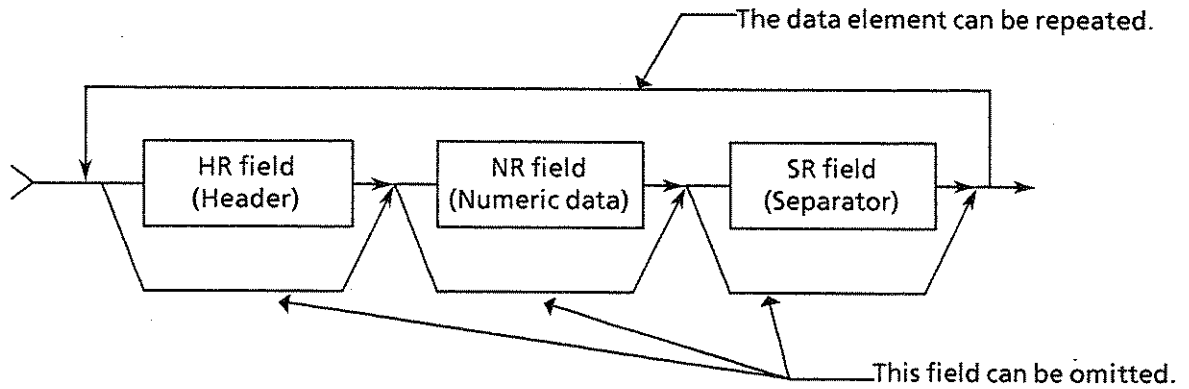

Fig. 6-1 Device-Message General Format

6.3.1 Symbolic notation of device messages

The line running from right to left in Fig. 6-1 represents a repetition of a message element. The line directing from left to right below each message element represents an omission of a message element. There are seven of these symbols as shown below:

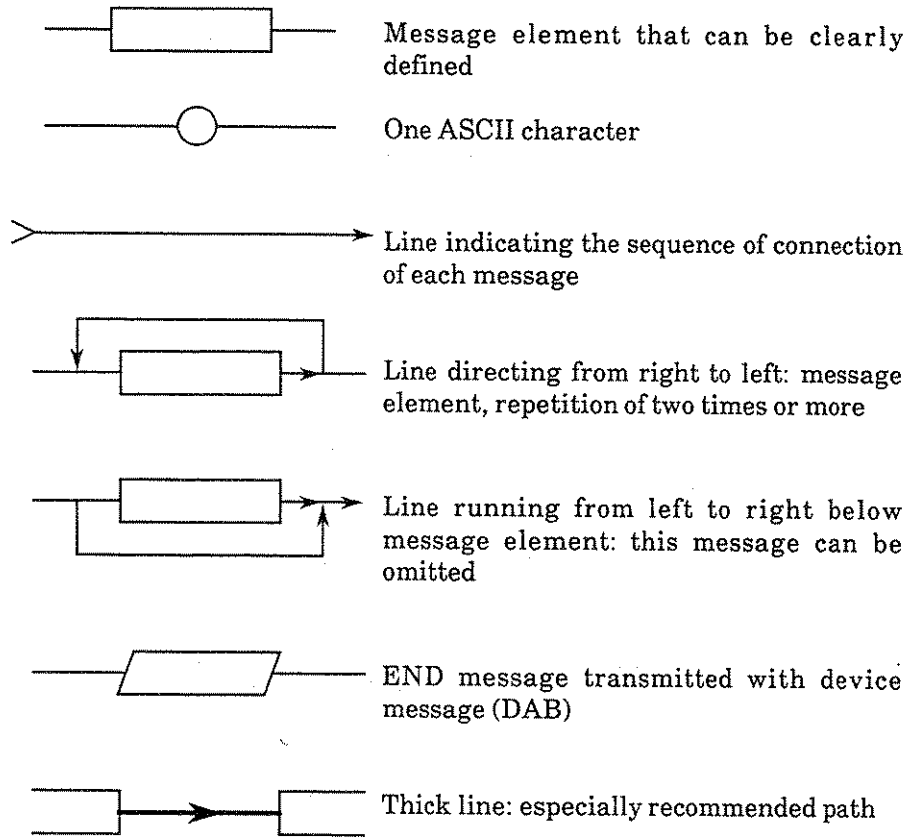

Fig. 6-2 Message Notation

6.3.2 Explaining each device message element

This paragraph explains HR, NR and SR device message elements.

(1) HR field (Header)

This is used at the beginning of a device message. Generally, it shows the purpose and function of numerical data following the header. If numerical data is not attached, the header expressed some predetermined setting.

Usually, upper-case alphabetic characters (A to Z) and numerals (0 to 9) are used as shown in the figure below. The first character must be an upper-case alphabetic character.

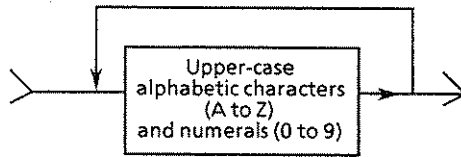

Fig. 6-3 HR-Field Format Syntax Diagram

(2) NR field (Numerical Representation)

The NR field contains numeric decimal data for execution of functions indicated by headers.

The NR1 format is for integers, NR2 format is for real numbers, and NR3 format is for exponents. A suffix (unit) can be placed at the end of each format.

The above-mentioned general format is shown in the figure below.

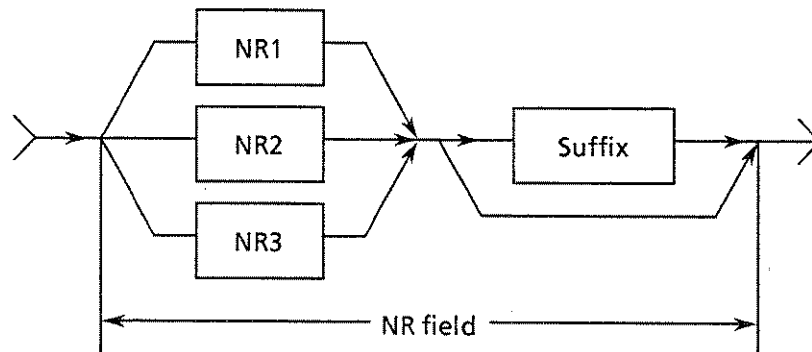
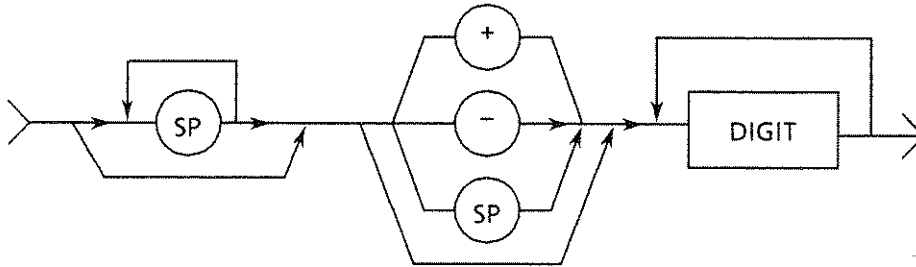

Fig. 6-4 NR-Field General Format

(a) NR1 format (integer)

- DIGIT: Numbers 0 to 9
- Space can be inserted at head
- + sign can be replaced with a space or omitted
- Do not use - (minus) sign with the number 0.



NR1 Format Syntax Diagram

Example: Set frequency to 903 MHz.

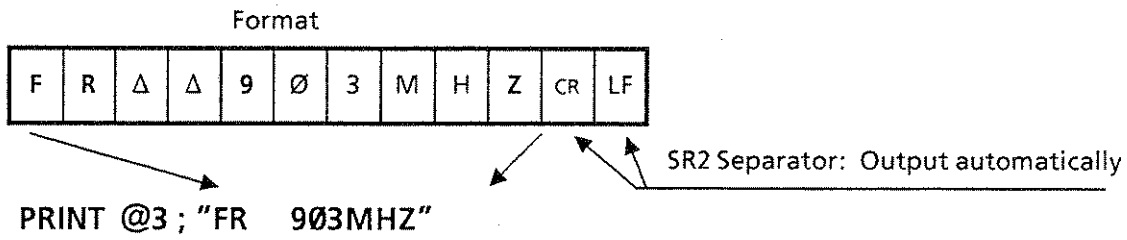

The above program can be created without space as PRINT @3 ; "FR9Ø3MHZ".

(b) NR2 format (real number)

- A decimal point must be included.
- The left side of the decimal point is the same as NR1 format,
- The right side of the decimal point uses no spaces.

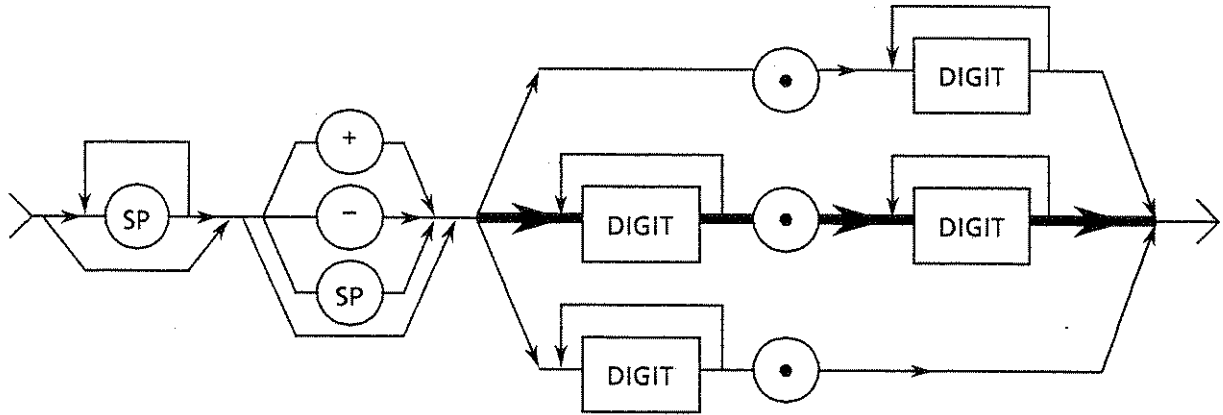

NR2 Format Syntax Diagram

Example: Set frequency deviation to 3.5 kHz (For suffix, see paragraph (d) below).

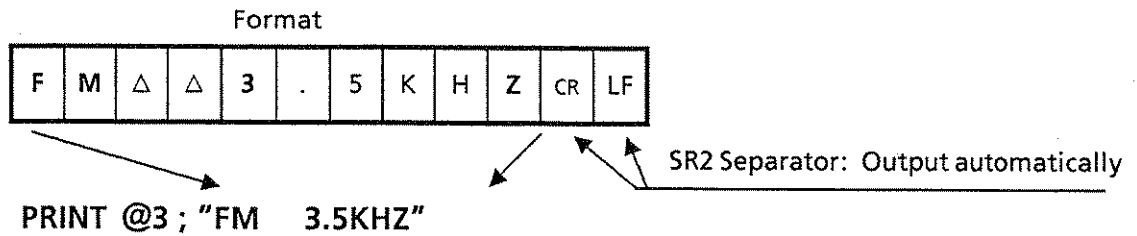

The above program can be created without space as **PRINT @3 ; "FM3.5KHZ"**.

(c) NR3 format (Floating point number)

- The left side of E is the same as in NR2 format.
- The standard number of exponent digits is two.

(Listener must operate regardless of the presence of decimal point.)

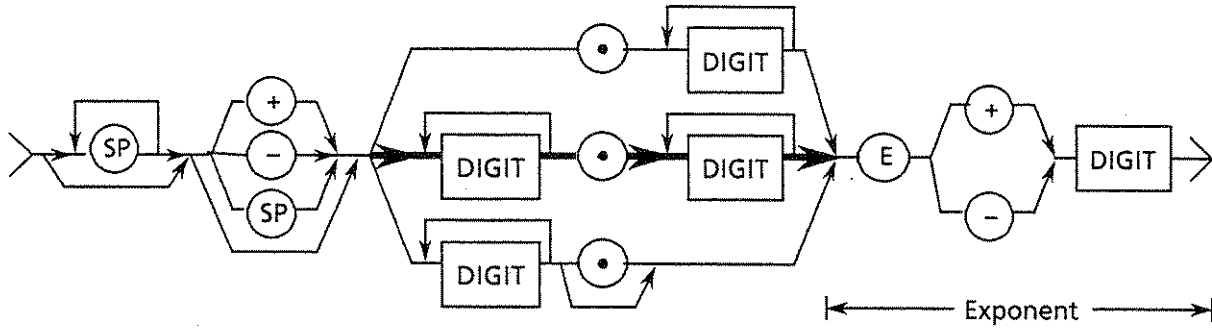

NR3 Format Syntax Diagram

(d) Suffix

- The suffix is the last part of the NR field, but there may be a space at the beginning.
- Only a space can be placed right after NR.
- ALPHA NUMERIC DIGITS: In addition to alphanumerics, / and * can be included

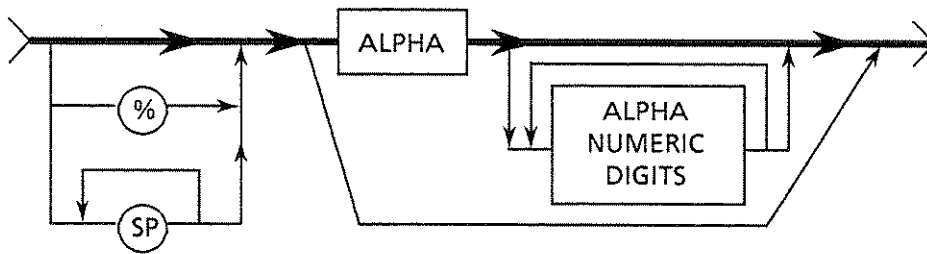

Suffix Syntax Diagram

The suffixes used with the MG3631A/MG3632A are shown in the Table below:

Suffix List

Unit	Suffix
GHz	GHZ
MHz	MHZ
kHz	KHZ
Hz	HZ
dBm	DBM
dB μ	DBU
V	V
mV	MV
μ V	UV
dB	DB
%	PC

(3) SR field (Separator)

The figure below shows the general format of device messages that use the SR field type (SR1, SR2, and SR3) expressions

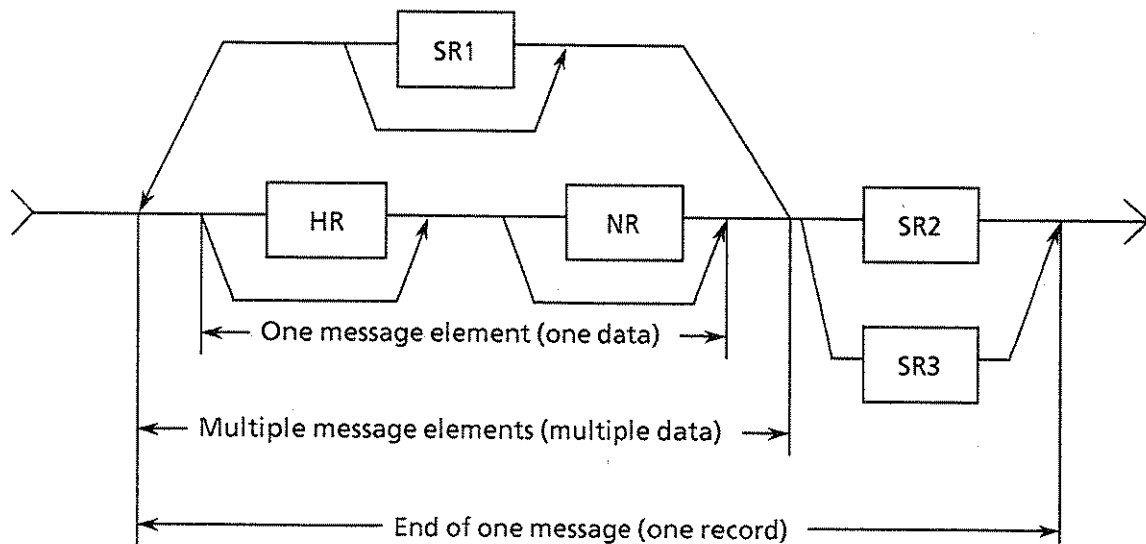

Fig. 6-5 Device-Message General Format

Hierarchy of Separator

Level	Name	ASCII code	Uni-line message	Meaning and usage
1	SR1 Separator	,	/	Identifies the end of the lowest level of message elements or data fields
		;		
2	SR2 Separator	CR	/	End of record Sent after the last DAB
		LF		
3	SR3 Separator		EOI	Sent simultaneously with the last DAB

As shown above, when there are two or more message elements (data) within a message (record), the SR field (SR1) is used to identify them as different data. It (SR2, SR3) is also used to indicate the end of a message (record).

(a) SR1 format (Level 1)

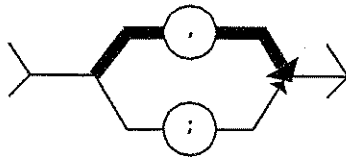

SR1 Syntax Diagram

An SR1 separator is the lowest level separator. Two separators exist at this level: the comma (,) and semicolon (;). The lowest order separator of these two is the comma (,) and is, for most applications, the preferred separator. The MG3631A/MG3632A uses a comma.

■ SR1 flexibility

A comma is the preferred SR1 separator, but the following are also recognized for SR1. (Since they are not used in some devices, separation using a comma is recommended.)

- Semicolon (;)
- Only spaces used for part of suffix.
- Separation of message element (data) can be identified explicitly only with HR field

(b) SR2 format (Level 2)

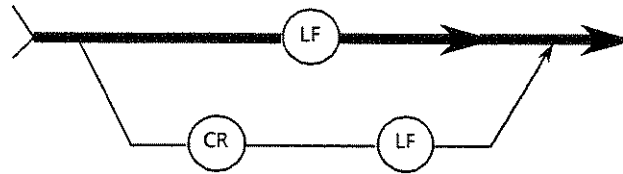

SR2 Syntax Diagram

SR2 is used to indicate the end of a message (record) generally expressed in one line. It is recommended that the Line Feed (LF) code is used. However, at present, carriage return (CR) code is also allowed for the following reasons.

1. Compatibility. Most products on the market use CR-LF code.
2. Generally, it is enough for the listener to recognize only the last LF as the separator and to ignore the CR code.

However, if the CR code is actually used, as with a printer, the CR code is required.

The MG3631A/MG3632A can accept a CR and LF, or simply an LF.

(c) SR3 format (Level 3)

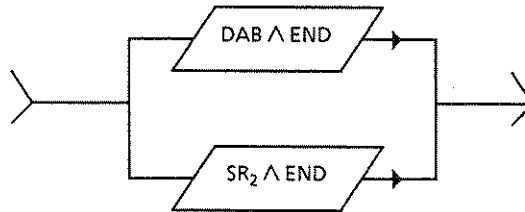

SR3 Syntax Diagram

SR3 is the highest level separator. In response to this, the END message (using the EOI line simultaneously with the last data byte, as shown above) is sent and received. The SR3 is used to indicate the end of binary data and the transfer completion of multiple messages. Generally, release (or modification) of the talker/listener specification is performed after SR3 is transferred.

The last data byte may be SR2.

6.3.3 Type of device messages

The following table describes device message classified by purpose of use.

Note: The MG3631A/MG3632A has only the control message.

Type	Use	Device status	Example																																				
Control message	Used to remote control device operation. The operating conditions of a device are manually set using front-panel switches and knobs; when remote controlled, however, conditions are set by sending this message from the controller (talker).	Listener	Set a frequency of 363.2 MHz and an output level of - 65 dBm. 1Ø PRINT @3; "FR363.2MHZ" 2Ø PRINT @3; "OL-65DBM" 3Ø END																																				
Measured value message	Used to indicate the results of measurement made by a device. The measurement results are sent from the device (talker) to the controller (listener) using an appropriate format.	Talker																																					
Status message	This message is output by a device to indicate its operating status as a response to the requests (polling) from the controller.	Talker	Messages are sent using 1-byte data (STB) shown below: <table border="1" style="margin-left: 20px;"> <thead> <tr> <th></th> <th>Bit7</th> <th>Bit6</th> <th>Bit5</th> <th>Bit4</th> <th>Bit3</th> <th>Bit2</th> <th>Bit1</th> <th>Bit0</th> </tr> <tr> <th>Value</th> <th>DI08</th> <th>DI07</th> <th>DI06</th> <th>DI05</th> <th>DI04</th> <th>DI03</th> <th>DI02</th> <th>DI01</th> </tr> </thead> <tbody> <tr> <td>1</td> <td>Extended bit or changed bit</td> <td>Service request</td> <td>Error</td> <td>Busy</td> <td>×</td> <td>×</td> <td>×</td> <td>×</td> </tr> <tr> <td>0</td> <td>—</td> <td>No service request</td> <td>No error</td> <td>Ready</td> <td>×</td> <td>×</td> <td>×</td> <td>×</td> </tr> </tbody> </table>		Bit7	Bit6	Bit5	Bit4	Bit3	Bit2	Bit1	Bit0	Value	DI08	DI07	DI06	DI05	DI04	DI03	DI02	DI01	1	Extended bit or changed bit	Service request	Error	Busy	×	×	×	×	0	—	No service request	No error	Ready	×	×	×	×
	Bit7	Bit6	Bit5	Bit4	Bit3	Bit2	Bit1	Bit0																															
Value	DI08	DI07	DI06	DI05	DI04	DI03	DI02	DI01																															
1	Extended bit or changed bit	Service request	Error	Busy	×	×	×	×																															
0	—	No service request	No error	Ready	×	×	×	×																															
Display message	Information for dialogue between measuring operator and measuring instrument. Messages are sent in the same format as used for the measured value.	Talker/ listener	<ul style="list-style-type: none"> ● Messages (date or time of measurement, measured value, etc.) sent from the controller (talker) to a device (listener) such as a CRT and printer. ● Messages sent from a device (talker) for display on the CRT screen of the controller (listener). 																																				

6.3.4 General format of MG3631A/MG3632A device messages

The MG3631A/MG3632A device message consists of control message only.

So the control message formats are explained in this paragraph.

(1) General format of control message

There are three types of control messages to control the MG3631A/MG3632A.

This explanation uses the command of the NEC (Japan) PC9800-series personal computer.

(a) Control-message format 1

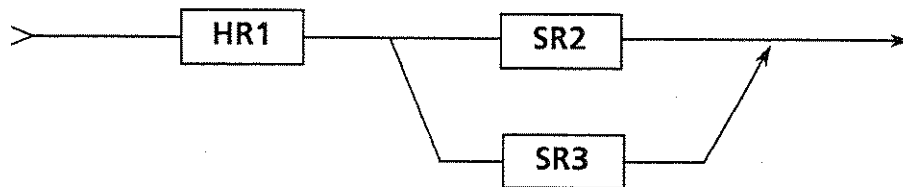

Example

Turn on AM.

```
PRINT @3;"AMO"
```

HR of AM ON

MG3631A/MG3632A GP-IB
address

(b) Control-message format 2

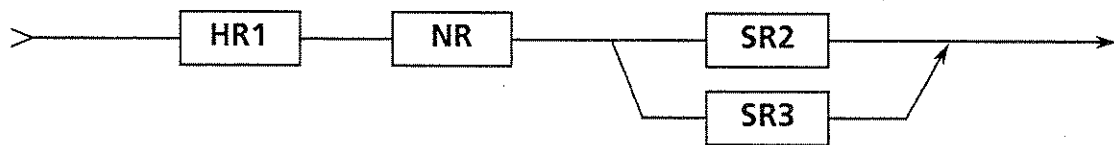

Example

Set carrier frequency to 123 MHz.

```
PRINT @3;"FR123MHZ"
```

(c) Control-message format 3

This format transfers multiple control messages at a time.

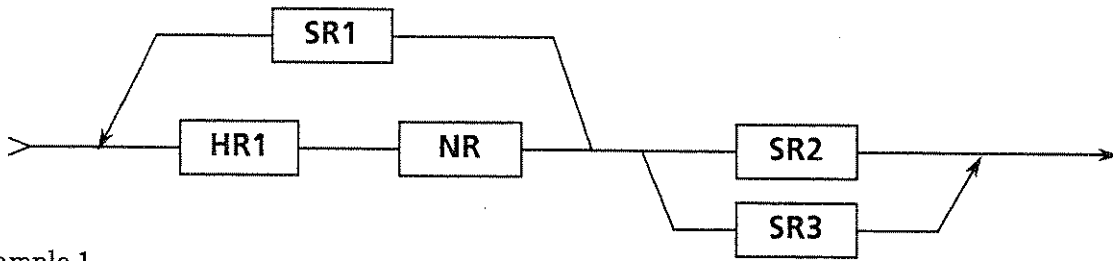

Example 1

```
PRINT @3;"FR10MHZ, OL-10DBM, FM75KHZ"
```

Frequency 10 MHz, Output level - 10 dBm, FM 75 kHz

Example 2

```
PRINT @3;"R3, FU"
```

Frequency resolution 1 kHz,
frequency knob up

6.4 Details of Device Messages

The MG3631A/MG3632A device messages consist of control messages only. So, control messages are described in this paragraph.

6.4.1 Setting frequency

The program codes for frequency settings are listed in the table below:

Program Codes for Setting Frequency

	Parameter	Program code
FREQUENCY	FREQUENCY	FR
	FREQUENCY INCREMENTAL STEP VALUE	DF
	FREQ INCREMENTAL STEP UP	IU
	FREQ INCREMENTAL STEP DOWN	ID
	FREQ KNOB UP	FU
	FREQ KNOB DOWN	FD
	FREQ RESOLUTION 10 Hz	R1
	FREQ RESOLUTION 100 Hz	R2
	FREQ RESOLUTION 1 kHz	R3
	FREQ RESOLUTION 10 kHz	R4
	FREQ RESOLUTION 100 kHz	R5
	FREQ RESOLUTION 1 MHz	R6
	FREQ RESOLUTION 10 MHz	R7
FREQ RELATIVE OFF	F0	
FREQ RELATIVE ON	F1	
FREQ OFFSET	F0	

(1) Setting frequency using data keys

Example

The various control messages shown below are used to set 363.2 MHz.

```
PRINT @3;"FR363200000"  
PRINT @3;"FR363200000HZ"  
PRINT @3;"FR363200KHZ"  
PRINT @3;"FR363.2MHZ"  
PRINT @3;"FR0.3632GHZ"  
PRINT @3;"FR.3632GHZ"
```

Note: Four frequency units Hz, kHz, MHz, and GHz can be used. The corresponding suffix codes used are as follows:

```
Hz   : "HZ"  
kHz  : "KHZ"  
MHz  : "MHZ"  
GHz  : "GHZ"
```

When the suffix codes are omitted, they are regarded as "HZ".

(2) Setting frequency using [INCR]

Frequency can be set in any chosen step within an appropriate range of the current frequency setting.

Example

```
100 PRINT @3;"FR363.2MHZ" ..... Set frequency to 363.2 MHz.  
110 PRINT @3;"DF12.5KHZ"..... Set increment frequency to 12.5 kHz.  
120 FOR I=1 TO 10 STEP 1          } Increase (or decrease) the frequency by  
130 PRINT @3;"IU"(or"ID")        } 12.5 kHz from 363.200 MHz to 363.225  
140 NEXT I                        } MHz (or 362.975 MHz)  
150 END
```

(3) Setting frequency and resolution using rotary knob

The frequency can be set with any resolution within an appropriate range of the current frequency setting.

Example

```
100 PRINT @3;"FR363.2MHZ" ..... Set frequency to 363.2 MHz.  
110 PRINT @3;"R2" ..... Set resolution to 100 Hz.  
120 FOR I=1 TO 10 STEP 1          } Increase (or decrease) the frequency by  
130 PRINT @3;"FU"(or"FD")        } 100 Hz from 363.200 MHz to 363.201  
140 NEXT I                        } MHz (or 362.199 MHz)  
150 END
```

(4) Setting relative frequency mode

Program code	Command
F1	Turn ON relative frequency mode
F0	Turn OFF relative frequency mode

Example

```

100 PRINT @3;"FR10.7MHZ"..... Set frequency to 10.7 MHz.
110 PRINT @3;"DF200HZ"..... Set increment step value to 200 Hz.
120 PRINT @3;"F1"..... Set relative frequency mode.
130 FOR I=1 TO 5 STEP 1
140 PRINT @3;"IU"
150 NEXT I
160 PRINT @3;"F0"..... Release relative frequency mode.
170 END
    
```

} Increase the frequency by 200 Hz from +0 to +1 kHz.

(5) Setting offset frequency

Program code	Command
F00Hz	Turn OFF frequency offset mode
F0	Turn ON frequency offset mode and set frequency offset value in NR field

Example

```

100 PRINT @3;"F010.7MHZ" ..... Set offset frequency to 10.7 MHz.
110 PRINT @3;"FR363.2MHZ"..... Set frequency to 363.2 MHz.
                                     363.2 MHz is displayed. However, the actual
                                     frequency is 352.5 MHz (363.2 - 10.7 = 352.5).
120 END
    
```

6.4.2 Setting output level

The program codes for setting the output level are shown in the table below:

	Parameter	Program code
OUTPUT LEVEL	LEVEL	OL
	LEVEL INCREMENTAL STEP VALUE	DL
	LEVEL INCREMENTAL STEP UP	LIU
	LEVEL INCREMENTAL STEP DOWN	LID
	LEVEL KNOB UP	LU
	LEVEL KNOB DOWN	LD
	LEVEL RESOLUTION 0.1 dB (1st digit)	L2
	LEVEL RESOLUTION 1 dB (2nd digit)	L3
	LEVEL RESOLUTION 10 dB (3rd digit)	L4
	LEVEL CONTINUOUS MODE OFF	CØ
	LEVEL MODE ON	C1
	LEVEL RELATIVE OFF	LØ
	LEVEL RELATIVE ON	L1
	RF OFF	RF
	RF ON	RO
	LEVEL OFFSET	LO
	LEVEL UNIT CHANGE to dBm	OLDBM
	LEVEL UNIT CHANGE to dB μ	OLDBU
	LEVEL UNIT CHANGE to V, mV or μ V	OLV
	OPEN-CIRCUIT VOLTAGE DISPLAY (EMF)	SPØ3
	TERMINATED VOLTAGE DISPLAY	SPØ4
RPP RESET	RP	

(1) Setting output level using data keys

Example

The various control messages shown below are used.

```
PRINT @3;"OL-15.2DBM" } .....Set output level to -15.2 dBm.
PRINT @3;"OL-15.2"   }
PRINT @3;"OL+23DBU"  } .....Set output level to +23 dBμ.
PRINT @3;"OL23DBU"   }
PRINT @3;"OL124MV"   } .....Set output level to 124 mV.
PRINT @3;"OLØ.124V"  }
```

Note: Five output level units dBm, dBμ, V, mV, and μV can be used.

```
dBm : "DBM"
dBμ : "DBU"
V   : "V"
mV  : "MV"
μV  : "UV"
```

When the suffix codes are omitted, they are regarded as DBM.

(2) Setting output level using [INCR]

The output level can be set with any step size within an appropriate range of the current output level setting.

Example

```
100 PRINT @3;"OLØDBM" .....Set output level to 0 dBm.
110 PRINT @3;"DL6DB" .....Set step output level to 6 dB.
120 FOR I=1 TO 10 STEP 1 }
130 PRINT @3;"LID"      } Decrease output level by 6 dB from 0 dBm to
140 NEXT I               } -60 dBm.
150 END
```

Note: Decibel (dB) units are used for the step output level and the corresponding suffix code is DB. When the suffix codes are omitted, they are regarded as DB.

(3) Setting output level and resolution using rotary knob

The output level can be set with any resolution within an appropriate range of the current output level setting.

Example

```

100 PRINT @3;"OL0DBM"..... Set output level to 0 dBm.
110 PRINT @3;"L3"..... Set resolution to 1 dB.
120 FOR I=1 TO 10 STEP 1
130 PRINT @3;"TOL"(or"EOL") } Increase (or decrease) output level by 1 dB from
140 NEXT I } 0 dBm to 10 dBm (or -10 dBm).
150 END

```

(4) Setting output-level continuous mode

Program code	Command
C1	Turn ON continuous mode.
C0	Turn OFF continuous mode to return to normal mode.

Example

```

100 PRINT @3;"OL-10DBM"..... Set output level to -10 dBm.
110 PRINT @3;"C1"..... Set continuous mode.
120 FOR I=1 TO 50 STEP 1
130 PRINT @3;"LD" } Decreases output 1 level continuously by 0.1 dB
140 NEXT I } from -10 to -15 dBm.
150 END

```

(5) Setting relative output level mode

Program code	Command
L1	Turn ON relative output level mode
L0	Turn OFF relative output level mode

Example

```

100 PRINT @3;"OL-10DBM"..... Set output level to -10 dBm.
110 PRINT @3;"L1"..... Set relative output level mode.
120 PRINT @3;"L3"..... Set resolution to 1 dB.
130 FOR I=1 TO 5 STEP 1
140 PRINT @3;"LD" } Decreases relative output level by 1 dB from +0
150 NEXT I } dB to -5 dB.
160 PRINT @3;"L0"..... Release relative output level mode.
170 END

```

(6) Setting offset output level

Program code	Command
LO0DB	Turn OFF output level offset mode and set output level offset value to 0 dB
LO	Turn ON output level offset mode and set output level offset value in NR field

Example

```

100 PRINT @3;"LO25DB"..... Set the output level offset value to 25 dB.
110 PRINT @3;"OL-30DBM"..... Set the output level to -30 dBm.
                                -30 dBm is displayed. However, the actual
                                output level is -55 dBm (-30-25=-55).

120 END

```

Note: Decibel (dB) units are used for offset output level and the corresponding suffix code is DB.
When the suffix codes is omitted, they are regarded as DB.

(7) ON/OFF control of output level

Program code	Command
RO	Turn ON output level to the previous level
RF	Turn OFF output level

Example

```

100 PRINT @3;"OL-30DBM"..... Set the output level to -30 dBm.
110 PRINT @3;"RF"..... Turn off the output level.
120 PRINT @3;"RO"..... Turn on the output level to return to the previous
                                level of -30 dBm.

130 END

```

Note: When a output level is set at the OFF state, the OFF state changes to the ON state and output level becomes the new set value.

(8) Changing voltage display mode between open-circuit and terminated modes

Program code	Command
SPØ3	Open-circuit voltage display mode
SPØ4	Terminated voltage display mode

(9) Changing output level units

The output level units are changed as described below:

Program code	Command
OLDBM	Change output level units (dB μ , V, mV and μ V) to dBm.
OLDBU	Change output level units (dBm, V, mV and μ V) to dB μ .
OLV	Change output level units (dBm and dB μ) to V, mV or μ V.

(10) Resetting RPP operation

Program code	Command
RP	Reset RPP operation.

6.4.3 Setting FM modulation

The program codes for setting FM modulation are shown in the table below:

Program Codes for Setting FM Modulation

Parameter	Program code
FM DEVIATION (MAIN SOURCE) FM DEVIATION (MIX SOURCE)	FM FMM
FM ON FM OFF	FM0 FMF
MOD MAIN SOURCE 1KHz MOD MAIN SOURCE 400 Hz MOD MAIN SOURCE AF MOD MAIN SOURCE EXT	M1 M3 M5 M7
MOD MIX SOURCE OFF MOD MIX SOURCE AF MOD MIX SOURCE EXT	SM0 SM5 SM7

(1) Setting FM frequency deviation using data keys

Example

```
100 PRINT @3;"FM3.5KHZ" .....Set FM deviation of MAIN modulation signal to 3.5 kHz.
110 PRINT @3;"FMM0.5KHZ".....Set FM deviation of MIX modulation signal to 0.5 kHz.
```

Note: Four FM frequency deviation units Hz, kHz, MHz, and GHz can be used. The corresponding suffix codes used are as follows:

```
Hz   : "HZ"
kHz  : "KHZ"
MHz  : "MHZ"
GHz  : "GHZ"
```

When the suffix codes are omitted, they are regarded as HZ.

(2) Setting FM signal source

Example

```
100 PRINT @3;"M1"..... Set MAIN modulation signal to 1 kHz.
110 PRINT @3;"SM7"..... Set MIX modulation signal to EXT.
```

Note: When a program code of FM signal source setting is sent at FM OFF state, the code is ignored and can not set the source.

(3) ON/OFF control of FM modulation

Sending the program codes listed below produce the indicated FM modulation commands.

Program code	Command
FMO	Turn ON FM modulation mode
FMF	Turn OFF FM modulation

Note: Turning ON the FM modulation mode can also be performed by setting FM deviation as described in paragraph (1) above.

6.4.4 Setting AM modulation

The program codes for setting AM modulation are shown in the table below:

Program Codes for Setting AM Modulation

Parameter	Program code
AM DEVIATION (MAIN SOURCE) AM DEVIATION (MIX SOURCE)	AM AMM
AM ON AM OFF	AMO AMF
MOD MAIN SOURCE 1 kHz MOD MAIN SOURCE 400 Hz MOD MAIN SOURCE AF MOD MAIN SOURCE EXT	M1 M3 M5 M7
MOD MIX SOURCE OFF MOD MIX SOURCE AF MOD MIX SOURCE EXT	SMØ SM5 SM7

(1) Setting AM modulation factor using data keys

Example

```

100 PRINT @3;"AM30PC" ... .. Set AM modulation factor of MAIN modulation
                                signal to 30%.
110 PRINT @3;"AMM5PC" ... .. Set AM factor of MIX modulation signal to 5%.
    
```

Note: The % unit is used for the AM modulation factor and the corresponding suffix code is PC. Omission of the suffix code is regarded as "PC".

(2) Setting AM signal source

Example

```
100 PRINT @3;"M1" ..... Set MAIN modulation signal to 1 kHz.  
110 PRINT @3;"SM5" ..... Set MIX modulation signal to AF.
```

Note: When a program code of AM signal setting is sent at AM OFF state, the code is ignored and can not set the source.

(3) ON/OFF control of AM modulation

Sending the program codes listed below produce the indicated AM modulation commands.

Program code	Command
AMO	Turn ON AM modulation mode
AMF	Turn OFF AM modulation

Note: Turning ON the AM modulation mode can also be performed by setting AM modulation factor as described in paragraph (1) above.

6.4.5 Setting FM deviation and AM modulation factor using up [^]/down [v] keys

The FM deviation and AM modulation factor can also be changed by using the [^]/[v] keys. The following table shows the program code to control this operation via GP-IB.

Frequency Deviation/Modulation Factor Setting Program Code

Function name	Program code
MOD STEP UP	MU
MOD STEP DOWN	MD
MOD RESOLUTION 1st digit (FM) or 1% (AM)	S1
MOD RESOLUTION 2nd digit (FM) or 10% (AM)	S2
MOD RESOLUTION 3rd digit (FM)	S3

(1) Setting resolution

Select the resolution with which to increment or decrement in advance using the program code "MU" or "MD".

Example 1

```

100 PRINT @3;"AM30PC" ..... Set the modulation factor to 30%.
110 PRINT @3;"M1" ..... Set the modulation signal to 1 kHz.
120 PRINT @3;"S1" ..... Set the resolution to 1%.
130 FOR I=1 TO 5
140 PRINT @3;"MU"
150 NEXT I
160 END
    
```

} Increased to 35% in 1% increments.

Example 2

```

100 PRINT @3;"FM3.5KHZ" ..... Set the FM deviation to 3.5 kHz.
110 PRINT @3;"M1" ..... Set the modulation signal to 1 kHz.
120 PRINT @3;"S1" ..... Set the resolution to 0.01 kHz.
130 FOR I=1 TO 5
140 PRINT @3;"MU"
150 NEXT I
160 END
    
```

} Increased to 3.55 kHz in 0.01 Hz increments.

(2) Resolution

The resolution selected by program code S1, S2, or S3 is different depending on whether the modulation mode is AM or FM and the value of frequency deviation.

Program code	FM	AM
	Resolution (deviation)	Resolution (modulation factor)
S1	0.01 kHz (0 to 9.99 kHz) 0.1 kHz (10 to 99.9 kHz) 1 kHz (100 to 200 kHz)	1% (0 to 100%)
S2	0.1 kHz (0 to 9.99 kHz) 1 kHz (10 to 99.9 kHz) 10 kHz (100 to 200 kHz)	10% (0 to 100%)
S3	1 kHz (0 to 9.99 kHz) 10 kHz (10 to 99.9 kHz) 10 kHz (100 to 200 kHz)	—————

Note: If S1, S2, or S3 is set when modulation is OFF, the setting is ignored; if S3 is set when in AM, the setting is ignored.

6.4.6 Setting AF modulation frequency

The program codes for setting AF modulation frequency are shown in the table below:

Program Codes for Setting AF Frequency

	Parameter	Program code
AF OSC	AF(AUDIO FREQUENCY)	AF
	AF INCREMENTAL STEP	DA
	AF INCREMENTAL STEP UP	AIU
	AF INCREMENTAL STEP DOWN	AID
	AF KNOB UP	AU
	AF KNOB DOWN	AD
	AF RESOLUTION 0.1 Hz	A1
	AF RESOLUTION 1 Hz	A2
	AF RESOLUTION 10 Hz	A3
	AF RESOLUTION 100 Hz	A4
	AF RESOLUTION 1 kHz	A5
	AF RESOLUTION 10 kHz	A6

Note: AF frequency can be set only when AF Oscillator (Option 04) is installed.

If not installed, the codes are ignored.

When modulation is performed with the AF oscillator, select AF as the modulation signal source. The AF frequency can be set even if in modulation OFF mode.

(1) Setting AF frequency using data keys

Example

The various control messages shown below are used to set AF 12.3 kHz.

```
PRINT @3;"AF12300"  
PRINT @3;"AF12300HZ"  
PRINT @3;"AF12.3KHZ"  
PRINT @3;"AF0.0123MHZ"  
PRINT @3;"AF0.0000123GHZ"  
PRINT @3;"AF.0000123GHZ"
```

Note: The four AF frequency units Hz, kHz, MHz, and GHz can be used. The corresponding suffix codes used are as follows:

```
Hz : "HZ"  
kHz : "KHZ"  
MHz : "MHZ"  
GHz : "GHZ"
```

When the suffix codes are omitted, they are regarded as "HZ".

(2) Setting AF frequency using [INCR]

The AF frequency can be set using any step size within an appropriate range of the current AF frequency setting.

Example

```
100 PRINT @3;"AF400HZ" ..... Set AF frequency to 400 Hz.
110 PRINT @3;"DA12HZ" ..... Set resolution to 12 Hz.
120 FOR I=1 TO 10 STEP 1
130 PRINT @3;"AIU"(or"AID") } Increase (or decrease) AF frequency by 12 Hz
140 NEXT I } from 400 Hz to 520 Hz (or 280 Hz).
150 END
```

(3) Setting AF frequency using rotary knob

The AF frequency can be set with any resolution within an appropriate range of the current AF frequency setting.

Example

```
100 PRINT @3;"AF400KHZ" ..... Set AF frequency to 400 Hz.
110 PRINT @3;"A1" ..... Set resolution to 0.1 Hz.
120 FOR I=1 TO 10 STEP 1
130 PRINT @3;"AU"(or"AD") } Increase (or decrease) AF frequency by 0.1 Hz
140 NEXT I } from 400 Hz to 401 Hz (or 399 Hz).
150 END
```

6.4.7 Setting external modulation input

The program codes for setting external modulation input are shown in the table below:

Program Code for Setting External Modulation Input

	Parameter	Program Code
External modulation input	AC COUPLE	EXA
	DC COUPLE	EXD
	POLARITY NORMAL	EXN
	POLARITY INVERT	EXI

(1) Changing external AC/DC coupling mode

Sending the program codes listed below change the AC/DC coupling mode of external modulation signal.

Program code	Command
EXA	Set AC mode.
EXD	Set DC mode.

(2) Changing external polarity

Sending the program codes listed below change the input polarity (Non-inverted/Inverted) of external modulation signal.

Program code	Command
EXN	Set non-inverted mode.
EXI	Set inverted mode.

6.4.8 Memory setting

The following table lists the program codes used to set memory functions.

Memory Setting Program Code

Function name	Program Code
MEMORY	FN
RECALL	RL
STORE	ST
SKIP	SK
SKIP RESET	SC
CLEAR	CL
ADDRESS UP	ADU
ADDRESS DOWN	ADD

(1) Memory store

Stores the panel conditions in memory.

Example

```
100 PRINT @3;"FN52ST" ..... Store the current set panel conditions in memory
                                address 52.
110 END
```

(2) Memory recall

Recalls memory contents.

Example

```
100 PRINT @3;"FN52RL" ..... Recall memory contents at address 52.
110 END
```

(3) Continuous memory recall

Recalls memory contents continuously.

Example: Recall memory contents from address 10 to 20.

```
100 PRINT @3;"FN10RL"
110 FOR I=1 TO 10
120 PRINT @3;"ADU"
130 NEXT I
140 END
```

(4) Memory skip setting

Sets some addresses to be skipped when continuously recalling memory contents.

Example

```
100 PRINT @3;"FN11SK" ..... Set address 11 for skip.  
110 END
```

(5) Resetting a memory-skip value

Resets a memory skip value.

Example

```
100 PRINT @3;"FN11SC" ..... Reset the skip setting value at address 11.  
110 END
```

(6) Memory clear

Clears memory contents.

Example

```
100 PRINT @3;"FN18CL" ..... Clear memory contents at address 18.  
110 END  
100 PRINT @3;"FN3.20CL" ..... Clear memory contents from addresses 3 to 20.  
110 END
```

6.4.9 Other settings

The MG3631A/MG3632A allows the following functions to be set via GP-IB.

Program Code

Function name	Program Code
INITIAL SET	SP00
BELL OFF	SP01
BELL ON	SP02
DISPLAY OFF	D0
DISPLAY ON	D1

(1) Initial setting

Initializes the MG3631A/MG3632A.

Program Code	Command
SP00	Intialize

Example

```
100 PRINT @3;"SP00" ..... Initialize the MG3631A/MG3632A.  
110 END
```

Note: The initial setting conditions can be changed by a special function (can only be set from the panel).

(2) Bell ON/OFF

Set bell sound ON or OFF that signals key operation or error occurrence.

Program Code	Command
SP01	Set bell sound OFF.
SP02	Set bell sound ON.

(3) Display ON/OFF

Turns all displays ON or OFF except POWER ON, STBY, and H and L LEDs.

Program Code	Command
D0	Set indicator OFF.
D1	Set indicator ON.

6.5 Sample Programs

This section describes how to produce a program to control the MG3631A/MG3632A and the MS2702A Spectrum Analyzer which are configured as shown below. Two sample programs are discussed here. One program is created using the N88-BASIC language for the PC9800-series computers (NEC), and the other is created using the BASIC language for the PACKET-series computer (ANRITSU).

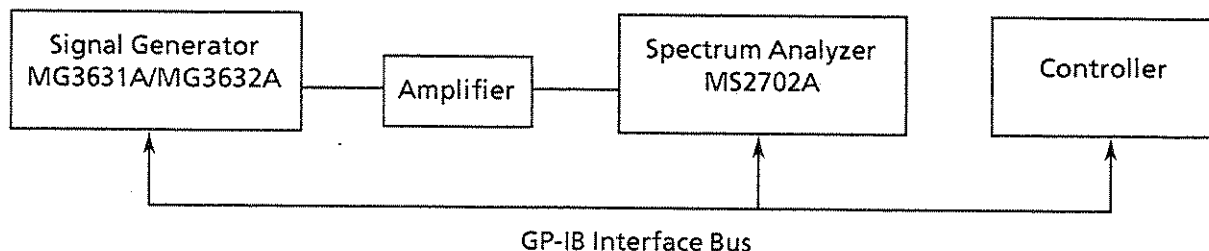

GP-IB Measurement System

The purpose of this program is such that a signal is applied from -30 dBm to 0 dBm in 2 dB steps from the MG3631A/MG3632A to the input of the amplifier and the output level of the amplifier is measured by the MS2802A.

Example 2: Sample program created using the BASIC language for the PACKET-series computers (ANRITSU)

```

100 ! * * * * *
110 ! *
120 ! *          INPUT vs OUTPUT characteristic of amplifier
130 ! *          measurement program
140 ! *
150 ! * * * * *
160 ! *
170 ! * * * * * * input measurement parameter * * * * *
180 !
190 INPUT PROMPT "MEASUREMENT FREQUENCY (MHz)":MF
200 !
210 ' * * * * * * * setting the MG3632A * * * * *
220 !
230 WRITE @103:"SP00"! . . . . . Initialize the MG3632A.
240 WRITE @103:"FR"&STR$(MF)&"MHZ"! . . . . . Set the frequency.
250 WRITE @103:"RF"! . . . . . Turn output OFF.
260 !
270 ' * * * * * * * setting the MS2702A * * * * *
280 '
290 WRITE @101:"INT"! . . . . . Initialize the MS2702A.
300 WRITE @101:"SPF 100KHZ"! . . . . . Set the frequency span to 100 kHz.
310 WRITE @101:"CNF "&STR$(MF)&"MHZ"! . . . . . Set the center frequency.
320 WRITE @101:"RLV 20"! . . . . . Set the reference level to 20 dBm.
330 !
340 ' * * * * * * * * * * * measurement * * * * *
350 !
360 PRINT " INPUT      OUTPUT      GAIN"
370 FOR LEVEL1=-30 TO 0 STEP 2
380 WRITE @103:"OL"&STR$(LEVEL1)&"DBM"! . . . . . Set the output level.
390 WAIT DELAY 2
400 WRITE @101:"SWP;MKPS  PEAK"! . . . . . Search the peak after one sweep.
410 WRITE @101:"MKL?"! . . . . . Request maker level read data.
420 READ @101:LEVEL2
430 PRINT USING "###.#dBm  ###.#dBm  ###.#dB";LEVEL1,LEVEL2,LEVEL2-
    LEVEL1
440 NEXT LEVEL1
450 !
460 END

```

Executed results:

INPUT	OUTPUT	GAIN
- 30.0 dBm	- 5.2 dBm	24.8 dB
- 28.0 dBm	- 3.2 dBm	24.8 dB
- 26.0 dBm	- 1.2 dBm	24.8 dB
- 24.0 dBm	.8 dBm	24.8 dB
- 22.0 dBm	2.8 dBm	24.8 dB
- 20.0 dBm	4.8 dBm	24.8 dB
- 18.0 dBm	6.8 dBm	24.8 dB
- 16.0 dBm	8.8 dBm	24.8 dB
- 14.0 dBm	10.8 dBm	24.8 dB
- 12.0 dBm	12.5 dBm	24.5 dB
- 10.0 dBm	13.0 dBm	23.0 dB
- 8.0 dBm	13.2 dBm	21.2 dB
- 6.0 dBm	13.3 dBm	19.3 dB
- 4.0 dBm	13.3 dBm	17.3 dB
- 2.0 dBm	13.3 dBm	15.3 dB
.0 dBm	13.3 dBm	13.3 dB

6.6 Control by MG3633A Program Code

When controlling the MG3631A/MG3632A with the MG3633A program codes; press [SHIFT], [0], [1], [5] and [2] on the front panel in advance to turn the Special function 152 (MG3633A compatible mode) ON.

Followings show the MG3633A program codes used by the MG3631A/MG3632A.

MG3633A Compatible-Mode Program Code

Item	Parameter	MG3633A Program code
Data	NUMERALS 0 to 9 MINUS DECIMAL POINT	0 to 9 — .
Unit	dB dBm dB μ V mV μ V GHz MHz kHz Hz %	DB DBM, DM DBU, DU V MU UV GHZ, GZ MHZ, MZ KHZ, KZ HZ PC
Fre- quency	FREQUENCY or CENTER FREQUENCY FREQUENCY INCREMENTAL STEP INCREMENTAL STEP UP FREQ INCREMENTAL STEP DOWN FREQ KNOB UP FREQ KNOB DOWN FREQ FREQ RESOLUTION 10 Hz FREQ RESOLUTION 100 Hz FREQ RESOLUTION 1 kHz FREQ RESOLUTION 10 kHz FREQ RESOLUTION 100 kHz FREQ RESOLUTION 1 MHz FREQ RESOLUTION 10 MHz FREQ RELATIVE ON FREQ RELATIVE OFF FREQ OFFSET	FR, FC, CF FIS UFR DFR TFR EFR R3 R4 R5 R6 R7 R8 R9 F0 FF FOS

*1 Setting the offset frequency turns the frequency offset mode ON, automatically.

MG3633A Compatible-Mode Program Code (Cont.)

Item	Parameter	MG3633A Program code
Output level	OUTPUT LEVEL or AMPLITUDE	OL, AP
	OUTPUT LEVEL INCREMENTAL STEP	OIS
	INCREMENTAL STEP UP OUTPUT LEVEL	UOL
	INCREMENTAL STEP DOWN OUTPUT LEVEL	DOL
	KNOB UP OUTPUT LEVEL	TOL
	KNOB DOWN OUTPUT LEVEL	EOL
	OUTPUT LEVEL RESOLUTION 0.1 dB	L0
	OUTPUT LEVEL RESOLUTION 1 dB	L1
	OUTPUT LEVEL RESOLUTION 10 dB	L2
	OUTPUT LEVEL CONTINUOUS MODE SET	LC
	OUTPUT LEVEL NORMAL MODE SET	LN
	OUTPUT LEVEL RELATIVE ON	LO
	OUTPUT LEVEL RELATIVE OFF	LF
	OUTPUT LEVEL ON	RO
	OUTPUT LEVEL OFF	RF
	RPP RESET	RS
	OUTPUT LEVEL OFFSET	OOS *2
	OUTPUT LEVEL UNIT dBm	OLDBM, OLDM, APDBM, APDM
	OUTPUT LEVEL UNIT dB μ	OLDBU, OLDU, APDBU, APDU
OUTPUT LEVEL UNIT V	OLV, APV	
AM modulation	AM DEPTH	AM *3
	KNOB UP AM	TAM
	KNOB DOWN AM	EAM
	AM RESOLUTION 2nd DIGIT (1% digit)	AD1
	AM RESOLUTION 3rd DIGIT (10% digit)	AD2
	INT AM MODE ON	A1 *3
	EXT AC AM MODE ON	A2 *3
	EXT DC AM MODE ON	A3 *3
	INT/EXT AC AM MODE ON	A4 *3
	INT/EXT DC AM MODE ON	A5 *3
	AM OFF	A0

*2 Setting the offset level turns the level offset mode ON, automatically.

*3 It is impossible to turn ON both the AM and FM simultaneously. The last setting modulation is only turned on.

MG3633A Compatible-Mode Program Code (Cont.)

Item	Parameter	MG3633A Program code
FM modulation	FM DEVIATION	FM *3
	KNOB UP FM	TFM
	KNOB DOWN FM	EFM
	FM RESOLUTION 1st DIGIT	FD0
	FM RESOLUTION 2nd DIGIT	FD1
	FM RESOLUTION 3rd DIGIT	FD2
	INT FM MODE ON	F1 *3
	EXT AC FM MODE ON	F2 *3
	EXT DC FM MODE ON	F3 *3
	INT/EXT AC FM MODE ON	F4 *3
	INT/EXT DC FM MODE ON	F5 *3
	FM OFF	F0
AF frequency	AF (AUDIO FREQUENCY)	AF
	INT MOD AF OSC	M0
	INT MOD 1kHz	M1
	INT MOD 400 Hz	M2
	AF INCREMENTAL STEP	AIS
	INCREMENTAL STEP UP AF	UAF
	INCREMENTAL STEP DOWN AF	DAF
	KNOB UP AF	TAF
	KNOB DOWN AF	EAF
	AF RESOLUTION 0.1 Hz	AR0
	AF RESOLUTION 1 Hz	AR1
	AF RESOLUTION 10 Hz	AR2
	AF RESOLUTION 100 Hz	AR3
	AF RESOLUTION 1 kHz	AR4
	AF RESOLUTION 10 kHz	AR5
Memory	STORE	ST
	RECALL	RC
	FUNCTION	FN
Initiali- zation	Initial setting	SP00 *4
Bell	Bell OFF	SP01
	Bell ON	SP02
Level display	Open-voltage display	SP03
	Terminal-voltage display	SP04
Offset	Level offset mode OFF	SP07 *5
	Frequency offset mode OFF	SP11 *5

*4 Set the initial condition of the MG3633A.

*5 Setting the offset value turns the offset mode ON, automatically.

SECTION 7 PERFORMANCE TESTS

This section describes MG3631A/MG3632A Synthesized Signal Generator performance tests.

7.1 Introduction

The performance-test procedures contained in paragraph 7.3.1 through 7.3.5 can be used to carry out once or twice a year: performance inspections upon receiving the MG3631A/MG3632A; routine maintenance inspections; and performance tests after repair or adjustment. Since checks are performed on the unit during normal system operation, no internal adjustments are necessary. Test important operating systems regularly as a method of preventive maintenance.

If an item does not satisfy the specifications at these tests, contact the Anritsu service department (paragraph 7.4).

7.2 Equipment Required for Performance Tests

Table 7-1 lists the equipment required for performance test.

Table 7-1 Equipment Required for Performance Test

Test item	Test equipment	Required performance*	Recommended model (Anritsu)	Reference paragraph
Output frequency	Frequency counter	100 kHz to 2.08 GHz	MF1603A	7.3.1
Output-level frequency characteristic	Power meter	100 kHz to 2.08 GHz – 30 dBm to + 20 dBm	ML4803A MA4601A (Sensor)	7.3.2
Output level accuracy	Level and attenuation calibrator Pre-amplifier Mixer Local signal source	100 kHz to 1.3 GHz – 20 dB μ to + 130 dB μ 100 kHz to 2080 MHz 1000 MHz to 2080 MHz 100 kHz to 2080 MHz	MG3632A	7.3.3
FM frequency deviation	Modulation analyzer	400 kHz to 2.08 GHz FM	MS616B	7.3.4
AM modulation factor	Modulation analyzer	400 kHz to 2.08 GHz AM	MS616B	7.3.5
Modulation distortion	Distortion meter	20 Hz to 100 kHz		7.3.4, 7.3.5

* Only part of the performance that covers the test item measurement range is listed.

7.3 Performance Tests

1. Output frequency
2. Output-level frequency characteristics
3. Output-level accuracy
4. FM frequency deviation and FM distortion
5. AM modulation factor and AM distortion

CAUTION: Warm-up the instrument for at least 30 minutes (unless otherwise noticed) and test the performance after the MG3631A/MG3632A has stabilized.
For the highest measurement accuracy, in addition to the above, tests must be made at room temperature, the AC line voltage must be stable, and noise, vibration, dust and humidity must not be a problem.

7.3.1 Output frequency

This tests if the set frequency is being output normally.

(1) Test specifications

- Frequency range 100 kHz to 1040 MHz (MG3631A)
100 kHz to 2080 MHz (MG3632A)
- Setting resolution 10 Hz

(2) Test equipment

- Frequency counter

(3) Setup

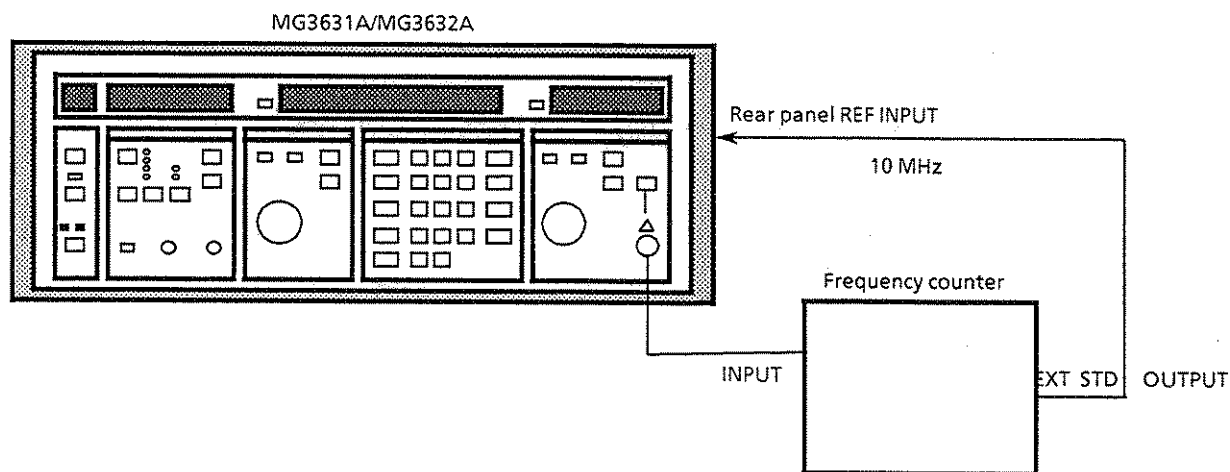

Fig. 7-1 Output Frequency

(4) Test procedure

Step	Procedure
1	Connect the standard frequency output (10 MHz) of the frequency counter to the external standard input (REF INPUT) of the MG3631A/MG3632A.
2	Connect the MG3631A/MG3632A output to the frequency counter input as shown in Fig. 7-3.
3	Set the MG3631A/MG3632A output level to +7 dBm. [LEVEL] [7] [GHz/dBm]
4	Set the MG3631A/MG3632A to any frequency. [FREQ] [4] [6] [5] [.] [5] [MHz/dBμ]
5	Check that the frequency counter reading is the same as the set value.
6	Change the frequency and repeat the test.

(5) Test precautions

The frequency counter indication may include a ± 1 count error.

7.3.2 Output-level frequency characteristic

(1) Test specifications

- Frequency characteristic: $\pm 0.5\text{dB}$ (≤ 1040 MHz)
 ± 1 dB (> 1040 MHz) (Only for MG3632A)

(2) Test equipment

- Power meter: 100 kHz to 2080 MHz

(3) Setup

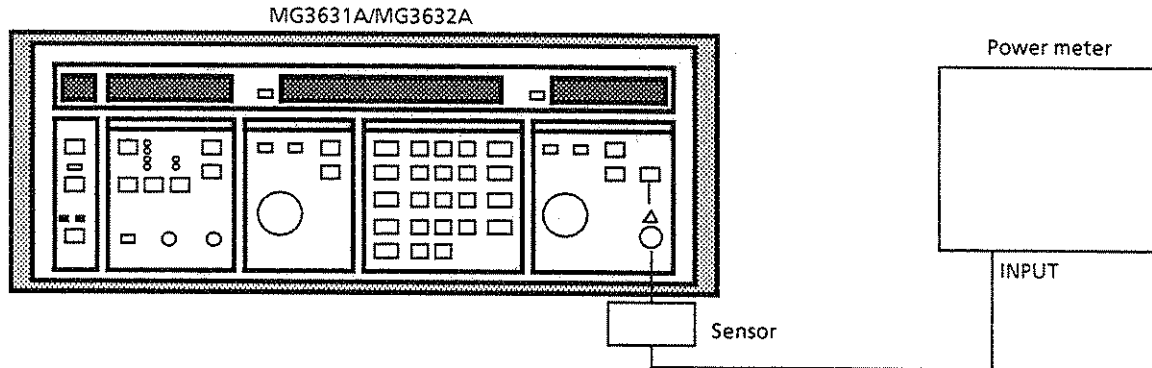

Fig. 7-2 Output-Level Frequency Characteristic

(4) Test procedure

Step	Procedure																				
1	Perform the zero-adjust of the power meter and the sensor sensitivity calibration.																				
2	Set the MG3631A/MG3632A output level to 0 dBm. [LEVEL] [0] [GHz/dBm]																				
3	Set the MG3631A/MG3632A to the frequency to be measured (for example, the table below).																				
	<table border="1"> <thead> <tr> <th>Frequency (MHz)</th> <th>0.1</th> <th>1</th> <th>100</th> <th>200</th> <th>300</th> <th>500</th> <th>1000</th> <th>1500</th> <th>2080</th> </tr> </thead> <tbody> <tr> <th>Level deviation (dB)</th> <td></td> <td></td> <td></td> <td></td> <td></td> <td></td> <td></td> <td></td> <td></td> </tr> </tbody> </table>	Frequency (MHz)	0.1	1	100	200	300	500	1000	1500	2080	Level deviation (dB)									
Frequency (MHz)	0.1	1	100	200	300	500	1000	1500	2080												
Level deviation (dB)																					
4	Set the calibration factor of the power meter sensor and read the output level.																				
5	Repeat steps 3 and 4.																				

(5) Test precautions

The MG3631A/MG3632A output-level frequency characteristic is specified at the RF OUTPUT connector. Therefore, when making measurements, connect the power sensor directly to the RF OUTPUT connector of the MG3631A/MG3632A.

7.3.3 Output-level accuracy

(1) Test specifications

- Output-level accuracy

± 1 dB	(-33 to +13 dBm)	}	(≥ 0.1 MHz, ≤ 1040 MHz)
± 1.5 dB	(-123 to -33.1 dBm)		
± 3 dB	(-133 to -123.1 dBm)		
± 1.5 dB	(-33 to +13 dBm)	}	(> 1040 MHz, ≤ 1700 MHz) (Only for MG3632A)
± 2.5 dB	(-123 to -33.1 dBm)		
± 4 dB	(-133 to -123.1 dBm)		
± 1.5 dB	(-33 to +13 dBm)	}	(> 1700 MHz) (Only for MG3632A)
± 3 dB	(-108 to -33.1 dBm)		
± 4 dB	(-133 to -108.1 dBm)		

(2) Test equipment

- Level and attenuation calibrator
100 kHz to 2080 MHz
- Pre-amplifier
100 kHz to 2080 MHz, gain 30 dB

(3) Setup

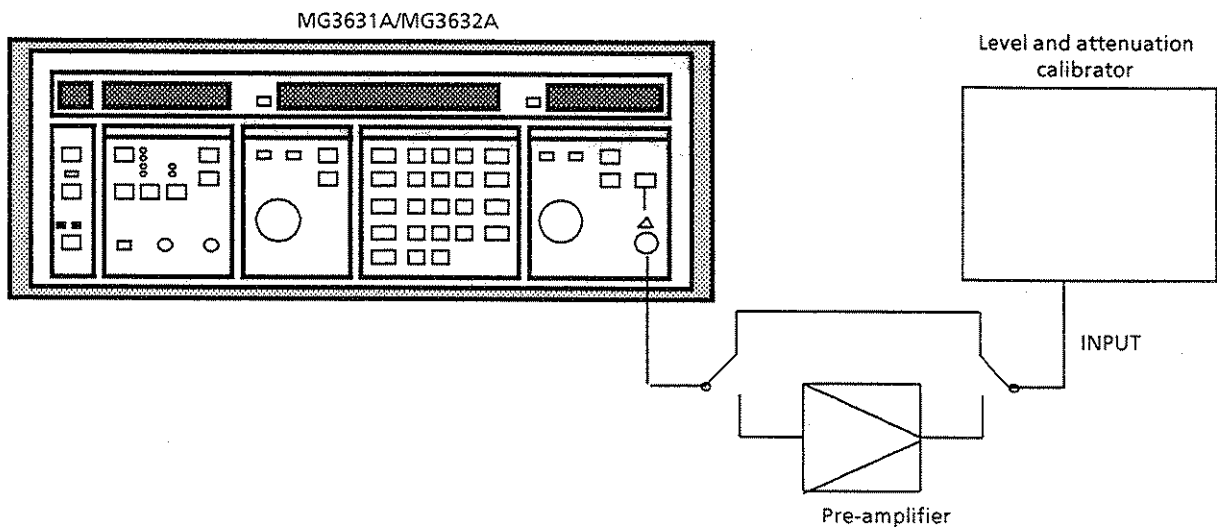

Fig. 7-3 Output-Level Accuracy

(4) Test procedure

Step	Procedure
1	Set the MG3631A/MG3632A to the measurement frequency and set the output level to +13 dBm.
2	Set a level and attenuation calibrator to the same frequency as the MG3631A/MG3632A and set the meter indication to 0 with the ATT and fine-adjustment control.
3	Attenuate the MG3631A/MG3632A output level in accordance with the table below. At the same time, change ATT of the calibrator by the same amount and read the deviation of the calibrator meter indication at that time.
4	Repeat Step 3 until the MG3631A/MG3632A output level reaches -113 dBm.
5	Next, insert a pre-amplifier between the MG3631A/MG3632A and calibrator to increase the input level to the calibrator for easy testing.
6	Set the meter indication to the same value as before the pre-amplifier was inserted, with the calibrator ATT and fine-adjustment control.
7	Attenuate the MG3631A/MG3632A output level again down to -133 dBm. At the same time, change the calibrator ATT by the same amount and read the deviation of the calibrator meter indication at that time.

(5) Test precautions

For frequencies that the calibrator cannot measure, use a mixer and local signal generator to convert to measurable ones.

MG3631A/ MG3632A set frequency / MG3631A/ MG3632A set output level (dBm)	100 kHz	1040 MHz	2080 MHz
+13			
+7			
+6			
+5			
+4			
+3			
+2			
+1			
0			
-1			
-2			
-3			
-13			
-23			
-33			
-43			
-53			
-63			
-73			
-83			
-93			
-103			
-113			
-123			
-133			

7.3.4 FM deviation and FM distortion

(1) Test specifications

Range: 0 to 200 kHz (However, 0 to 100 kHz at 130 to 260 MHz)

Accuracy: \pm (5% of indicated value + 20 Hz) (At \geq 0.5 MHz, $f_m = 1$ kHz, demodulation band 0.3 to 3 kHz)

Distortion: ≤ -45 dB (At \geq 0.5 MHz, $f_m = 1$ kHz, deviation 3.5 kHz/22.5 kHz)

(2) Test equipment

- Modulation analyzer
- Distortion meter

(3) Setup

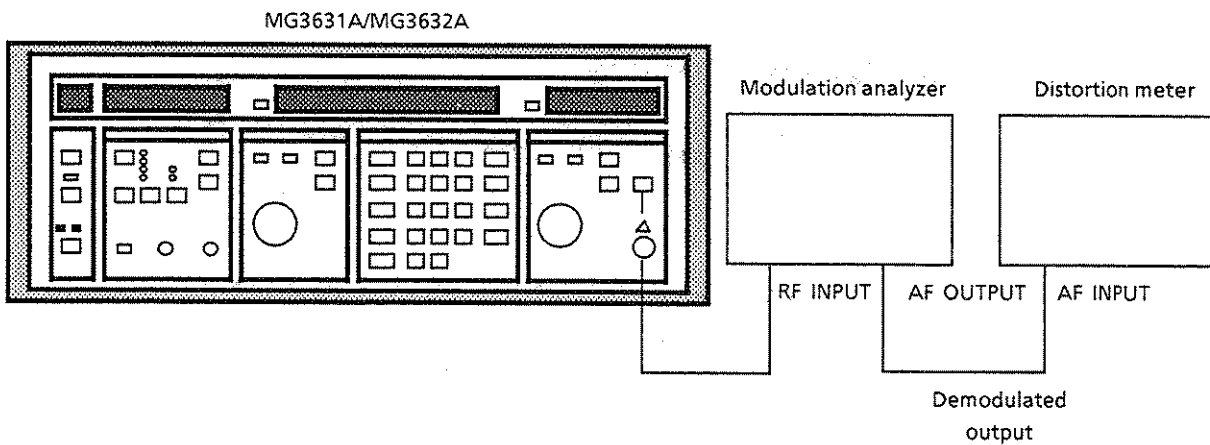

Fig. 7-4 FM Deviation and FM Distortion

(4) Test procedure

Step	Procedure
	<u>FM deviation accuracy</u>
1	Set the MG3631A/MG3632A output level to +7 dBm. [LEVEL] [7] [GHz/dBm]
2	Set the MG3631A/MG3632A frequency to the measurement frequency. [FREQ] [1] [5] [0] [0] [MHZ/dBμ]
3	Turn on the MG3631A/MG3632A FM. [FM ON/OFF] Select 1 kHz with SOURCE section key.
4	Set the MG3631A/MG3632A FM frequency deviation. [MOD] [1] [0] [0] [kHz/mV]
5	Read the modulation analyzer indication to test the FM frequency deviation.
6	Change the MG3631A/MG3632A FM frequency deviation and repeat the test.
	<u>FM distortion</u>
7	Set the MG3631A/MG3632A FM frequency deviation to 3.5 kHz and 22.5 kHz. [MOD] [3] [.] [5] [kHz/mV], [MOD] [2] [2] [.] [5] [kHz/mV]
8	Test the modulation-analyzer demodulated-output distortion with the distortion meter.

(5) Test precautions

- Test FM deviation by the modulation-analyzer with a 0.3 to 3 kHz demodulation-bandwidth. Test FM distortion by the modulation-analyzer with a 0.3 to 15 kHz or 0.3 to 20 kHz demodulation-bandwidth.
- If a modulation analyzer with a large residual FM is used, when the FM deviation is small, distortion measurement will be adversely affected. Therefore, use a modulation analyzer with a small residual FM.

7.3.5 AM modulation factor and AM distortion

(1) Test specifications

- Range: 0% to 100% ($A_t \geq 0.4$ MHz, $\leq +7$ dBm, $AM \leq 90\%$, $f_m = 1$ kHz, demodulation band 0.3 to 3 kHz)
- Accuracy: \pm (5% of indicated value + 2%) ($A_t \geq 0.4$ MHz, $\leq +7$ dBm, $f_m = 1$ kHz)
- Distortion: ≤ -40 dB ($A_t f_m = 1$ kHz, 30%)
 ≤ -30 dB ($A_t f_m = 1$ kHz, 80%)

(2) Test equipment

- Modulation analyzer
- Distortion meter

(3) Setup

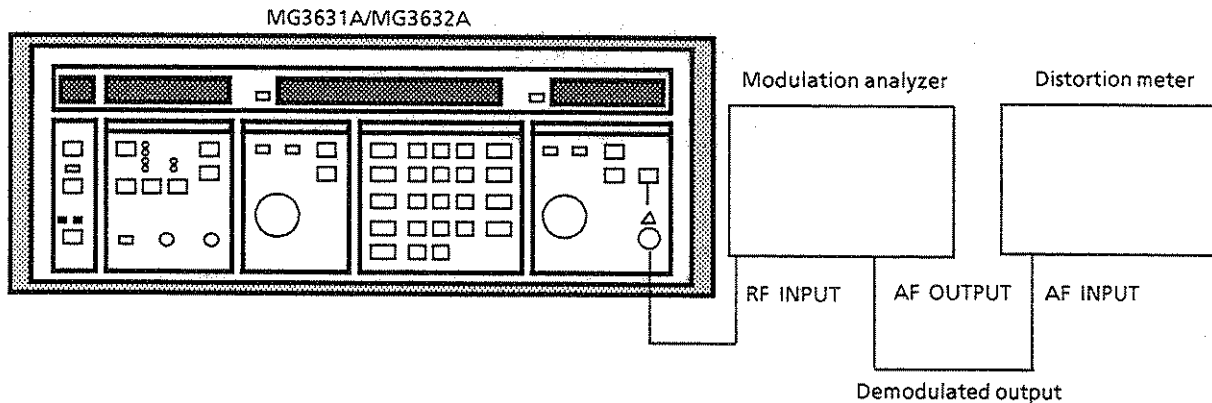

Fig. 7-5 AM Modulation Factor and AM Distortion

(4) Test procedure

Step	Procedure
<u>AM modulation-factor accuracy</u>	
1	Set the MG3631A/MG3632A output level to +7 dBm. [LEVEL] [7] [GHz/dBm]
2	Set the MG3631A/MG3632A frequency to the test frequency. [FREQ] [4] [6] [5] [MHz/dBμ]
3	Turn on the MG3631A/MG3632A AM mode. [AM ON/OFF] Select 1 kHz with SOURCE section key.
4	Set the MG3631A/MG3632A AM modulation factor. [MOD] [8] [0] [kHz/mV] (%)
5	Read the modulation-analyzer indication to test the AM modulation factor.
6	Change the MG3631A/MG3632A AM modulation factor and repeat the test.
<u>AM modulation-factor distortion</u>	
7	Set the MG3631A/MG3632A AM modulation factor to 30% and 80%.
8	Test the modulation-analyzer demodulated-output distortion with the distortion meter.

(5) Test precautions

For AM modulation-factor accuracy test, set the modulation-analyzer demodulation bandwidth to 0.3 to 3 kHz, and for AM distortion measurement, set the demodulation bandwidth to 0.3 to 15 kHz or 0.3 to 20 kHz.

7.4 Service

When the instrument is damaged or does not operate normally, contact the sales agent or ANRITSU for repair.

When requesting repair, please specify the following:

- (a) Instrument name and the serial No. on the rear panel
- (b) Trouble symptoms
- (c) Name and office of person(s) to be contacted during or after repair

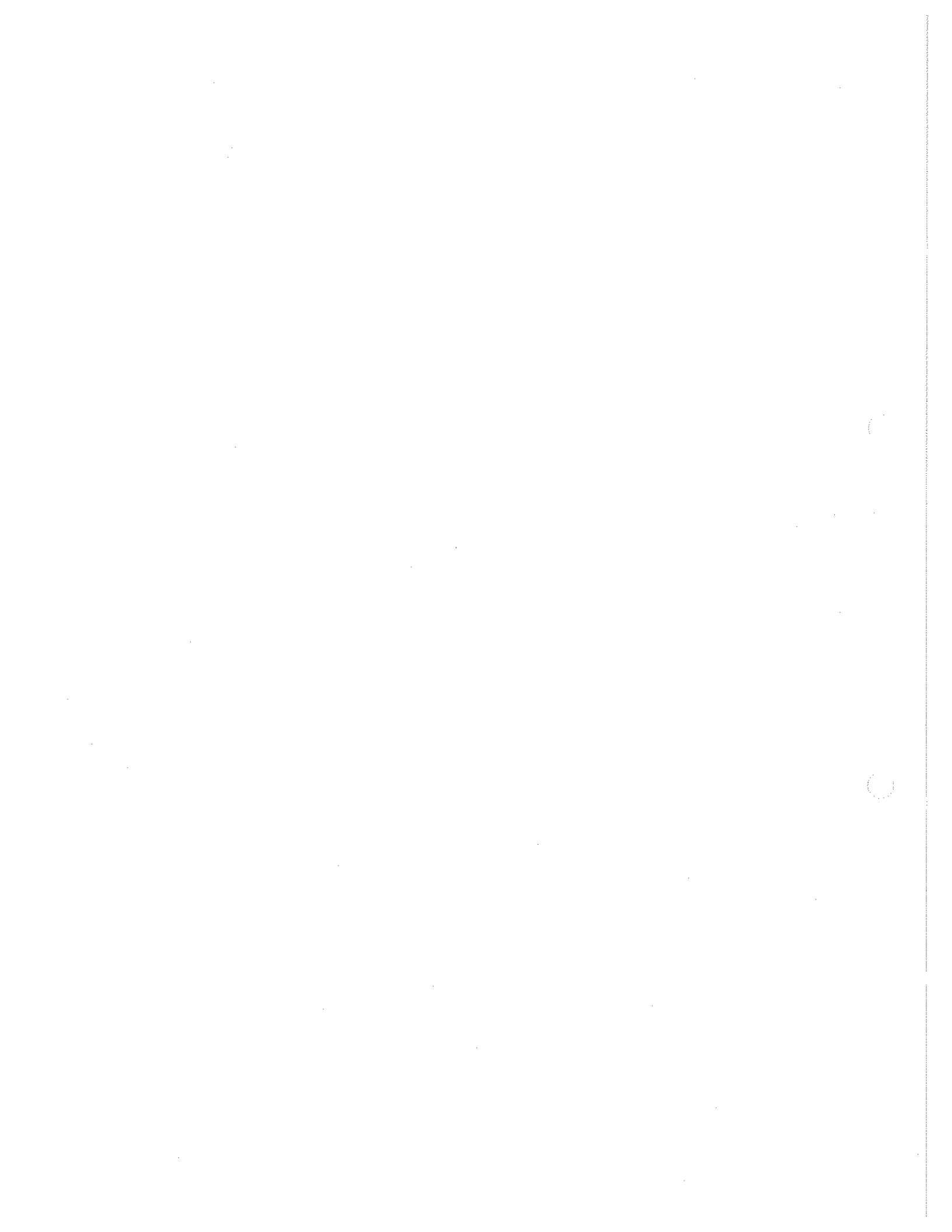

SECTION 8 CALIBRATION

This section describes the MG3631A/MG3632A Synthesized Signal Generator calibration.

8.1 Introduction

The MG3631A/MG3632A internal reference oscillator frequency must be calibrated periodically about once or twice a year.

If an item does not satisfy the specifications at calibration, contact the ANRITSU service department.

8.2 Equipment Required for Calibration

Table 8-1 lists the calibration equipment.

Table 8-1 Equipment Required for Calibration

Test item	Test equipment	Required performance*	Recommended model (Anritsu)
Reference oscillator frequency accuracy	Oscilloscope	10 MHz, external trigger possible	_____
	Frequency counter	100 kHz to 2.08 GHz, $< 2 \times 10^{-8}/\text{day}$	MF1603A
	Frequency standard	10 MHz, $\approx 1 \times 10^{-10}/\text{day}$	_____
Frequency accuracy in DC-FM mode	Frequency counter	100 kHz to 2.08 GHz, $< 2 \times 10^{-8}/\text{day}$	MF1603A

* Only part of the performance that covers the test item measurement range is listed.

8.3 Calibration

The MG3631A/MG3632A internal reference oscillator frequency and carrier frequency accuracy in DC-FM mode are calibrated.

The reference oscillator frequency specifications are as follows:

Reference oscillator	Frequency	Aging rate	Temperature characteristics
Standard type	10 MHz	$2 \times 10^{-7}/\text{day}$	$\pm 1 \times 10^{-6}$ (0° to 50°C)
Option 01	10 MHz	$2 \times 10^{-8}/\text{day}$	$\pm 5 \times 10^{-8}$ (0° to 50°C)
Option 02	10 MHz	$5 \times 10^{-9}/\text{day}$	$\pm 5 \times 10^{-8}$ (0° to 50°C)
Option 03	10 MHz	$2 \times 10^{-9}/\text{day}$	$\pm 1.5 \times 10^{-8}$ (0° to 50°C)

8.3.1 Reference oscillator frequency calibration using frequency standard

This paragraph describes calibration when options 01 to 03 are installed.

Since the MG3631A/MG3632A 10 MHz reference oscillator stability is $\pm 2 \times 10^{-8}/\text{day}$ or less, a standard signal generator, which either receives a standard signal or receives a color television subcarrier (signal locked to a rubidium atomic standard) and generates a signal locked to this signal, is used as the frequency standard.

(1) Setup

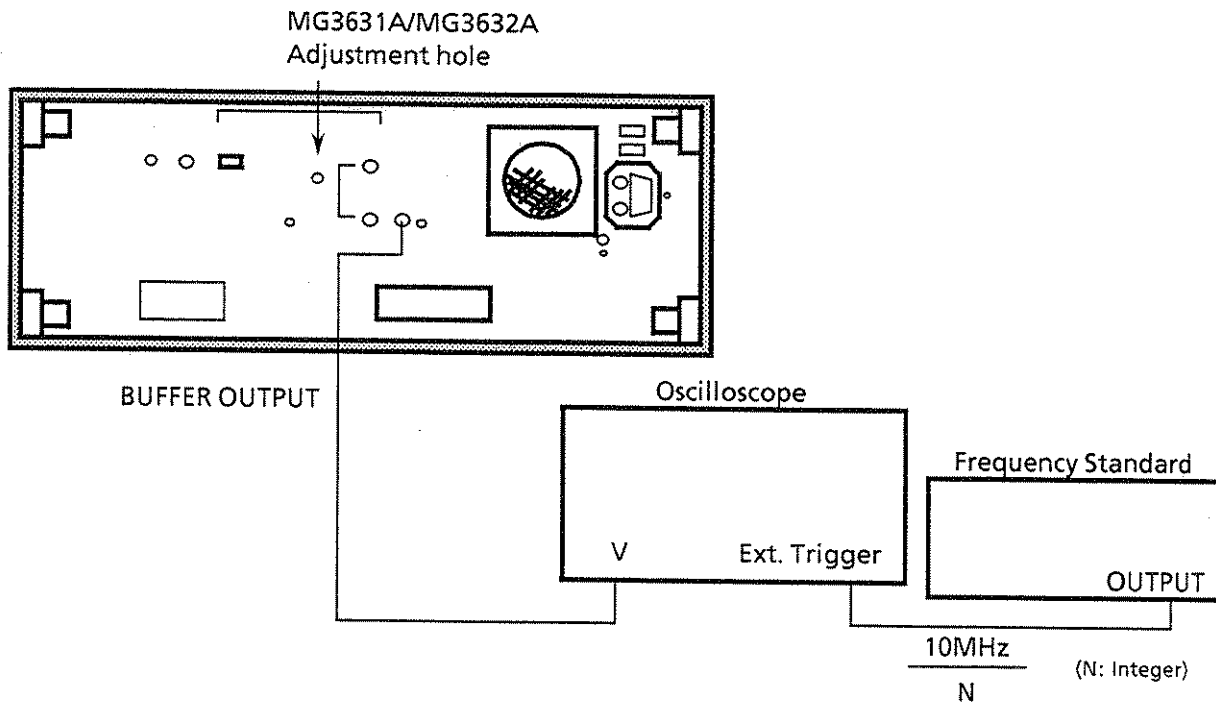

Fig. 8-1 Reference Oscillator Frequency Calibration using Frequency Standard

(2) Procedure

Step	Procedure
1	Set up the equipment as shown in Fig. 8-1 in a room at $23^{\circ} \pm 5^{\circ}\text{C}$.
2	To warm-up the MG3631A/MA3632A reference oscillator, set the POWER switch to STBY and leave the MG3631A/MA3632A in that state for 24 hours.
3	After 24 hours, set the MG3631A/MA3632A POWER switch to ON.
4	Apply the standard frequency signal to the oscilloscope external trigger input. Also, apply the 10 MHz reference output signal from the BUFFER OUTPUT connector on the MG3631A/MA3632A rear panel to the oscilloscope vertical axis X.
5	Adjust the oscilloscope so that the input waveform can be observed. When the input waveform on the oscilloscope moves to the right or left and is not synchronized, the reference oscillator frequency does not match the standard frequency.
6	Adjust the potentiometer (inside the reference-oscillator calibration-hole at the MG3631A/MA3632A rear cover shown in Fig. 8-1) so that the input waveform on the oscilloscope does not move to the left or right.

8.3.2 Reference oscillator frequency accuracy calibration using counter

This paragraph describes calibration when Options 01 to 03 are not installed: that is, for the standard instrument.

(1) Setup

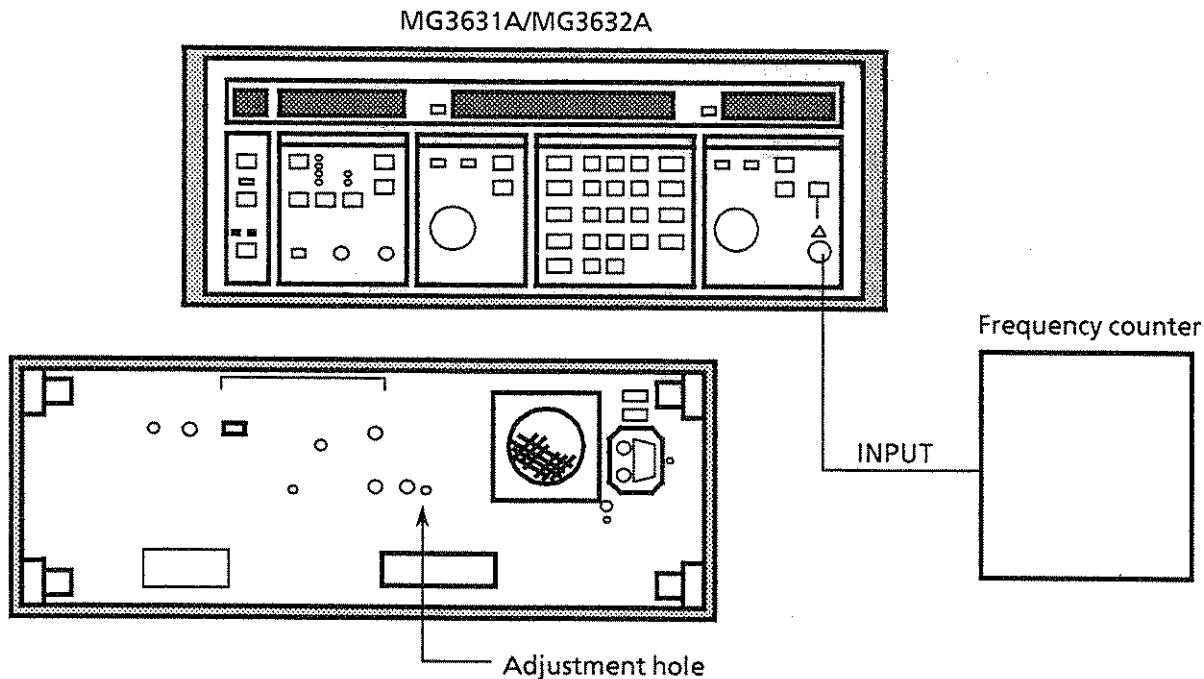

Fig. 8-2 Reference Oscillator Frequency Calibrationn Using Frequency Counter

(2) Procedure

Step	Procedure
1	Setup the equipment as shown in Fig. 8-2.
2	Set the MG3631A/MG3632A frequency to 1000 MHz and output level to +7 dBm.
3	Set the frequency counter resolution to 10 Hz or less.
4	While reading the frequency with the frequency counter, adjust the FREQ ADJ potentiometer (at the MG3631A/MG3632A rear cover shown in Fig. 7-2) with a screwdriver so that the frequency counter reads 1000 MHz.

8.3.3 Calibrating frequency accuracy at DC-FM modulation

Carrier frequency accuracy calibration at DC-FM modulations is described in this paragraph.

(1) Setup

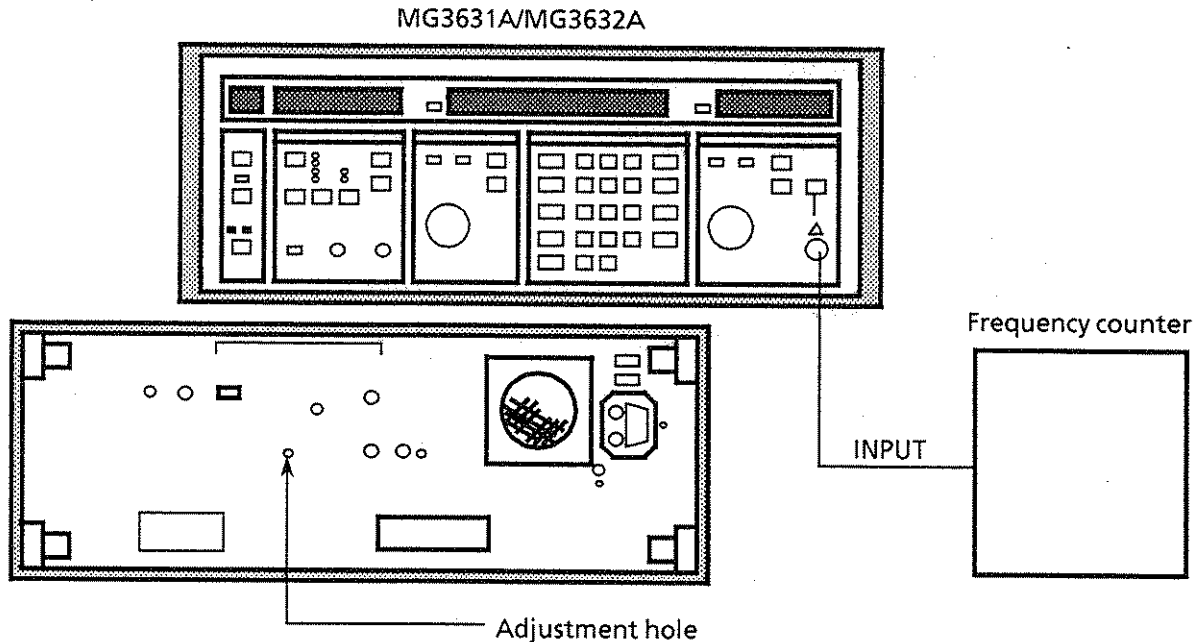

Fig. 8-3 Calibrating Frequency at DC-FM Modulation

(2) Procedure

Step	Procedure
1	Setup as shown in Fig. 8-3.
2	Set the MG3631A/MG3632A frequency to 1000 MHz.
3	Set the MG3631A/MG3632A FM modulation to deviation 10 kHz, the modulation signal to EXT and the AC/DC coupling switch to DC. Select EXT using the SOURCE section key.
4	Maintain this setting for at least two hours to preheat the MG3631A/MG3632A FM oscillator.
5	Set the frequency counter read resolution to 10 Hz or less.
6	Using the driver, turn the DC FM ADJ potentiometer on the rear of the MG3631A/MG3632A to specify 1000 MHz while the frequency is being read by the frequency counter.

SECTION 9 STORAGE AND TRANSPORTATION

This section describes daily maintenance, storage, and transportation of the MG3631A/MG3632A.

9.1 Daily Servicing and Preventive Maintenance

To prevent degradation of the performance of the MG3631A/MG3632A, the MG3631A/MG3632A should be operated correctly under the specified conditions. Calibration and performance tests should also be performed routinely.

The regular servicing method and interval are shown in Table 9-1.

Table 9-1 Regular Servicing

	Period	Method
Soiling	<ul style="list-style-type: none"> • Before long-term storage • When used in dusty locations • When noticeable dust and dirt have accumulated inside cabinet 	Wipe with damp cloth and soapy water or cleaning solvent if proper ventilation is provided.* (DAIFLON)
Dust		Open cabinet and blow out dust with compressed air, taking care to shield face from dust or loose particles.
Lubrication	None	
Loose screws	When detected	Retighten with recommended tool

* Do not use acetone or benzene; the paint finish may be damaged.

9.2 Storage Precautions

This paragraph describes the precautions to take when storing the MG3631A/MG3632A for a long time.

9.2.1 Precautions before storage

1. Wipe any dust and fingermarks off the cabinet.
2. Check the performance as described in SECTION 7 to confirm that the MG3631A/MG3632A operates normally.
3. The maximum and minimum storage temperature range is 60° to -20°C. The maximum humidity is 90%.
4. Avoid storing it in locations where it may be exposed to direct sunlight, condensation (more than 90%), excessive dust, or active gases.

9.2.2 Recommended storage conditions

In addition to meeting the conditions listed in paragraph 9.2.1, the MG3631A/MG3632A should preferably be stored where:

1. Temperature is 0° to 30°C
2. Humidity is 40% to 80%
3. Temperature and humidity are stable

Before using the MG3631A/MG3632A after storage, check the performance as described in SECTION 7.

9.3 Repacking and Transportation

When transporting the MG3631A/MG3632A over long distances, observe the precautions described below.

9.3.1 Repacking

Use the original packing materials. If the original packing materials were thrown away or destroyed, repack the MG3631A/MG3632A as follows:

1. Install the protective covers over the front and rear panels.
2. Wrap the MG3631A/MG3632A in plastic or similar material.
3. Obtain a cardboard, wood, or aluminum box 10 to 15 cm larger than the MG3631A/MG3632A on all sides.
4. Put the MG3631A/MG3632A in the center of the box and fill the surrounding space with shock absorbent material.
5. Secure the box with twine, tape, or bands.

Note: It is easy to repack the MG3631A/MG3632A if the original packing materials are saved.

9.3.2 Transportation

Transport the MG3631A/MG3632A under the storage conditions recommended in paragraph 9.2.2.

APPENDIX A
DEVICE MESSAGE IN ALPHABETIC ORDER

Device Message in Alphabetic Order (1/4)

Program code	Parameter	Classification
A1	AF RESOLUTION 0.1 Hz	AF OSC
A2	AF RESOLUTION 1 Hz	AF OSC
A3	AF RESOLUTION 10 Hz	AF OSC
A4	AF RESOLUTION 100 Hz	AF OSC
A5	AF RESOLUTION 1 kHz	AF OSC
A6	AF RESOLUTION 10 kHz	AF OSC
AD	AF KNOB DOWN	AF OSC
ADD	ADDRESS DOWN	MEMORY
ADU	ADDRESS UP	MEMORY
AF	AF (AUDIO FREQUENCY)	AF OSC
AID	AF INCREMENTAL STEP DOWN	AF OSC
AIU	AF INCREMENTAL STEP UP	AF OSC
AM	AM MODULATION FACTOR (MAIN SOURCE)	MODULATION [AM]
AMF	AM OFF	MODULATION [AM]
AMM	AM MODULATION FACTOR (MIX SOURCE)	MODULATION [AM]
AMO	AM ON	MODULATION [AM]
AU	AF KNOB UP	AF OSC
CØ	LEVEL CONTINUOUS MODE OFF	OUTPUT LEVEL
C1	LEVEL CONTINUOUS MODE ON	OUTPUT LEVEL
CL	CLEAR	MEMORY
DØ	DISPLAY OFF	etc
D1	DISPLAY ON	etc
DA	AF INCREMENTAL STEP VALUE	AF OSC
DB	dB	UNIT
DBM	dBm	UNIT
DBU	dBµ	UNIT

Device Massage in Alphabetic Order (2/4)

Program code	Parameter	Classification
DF	FREQUENCY INCREMENTAL STEP VALUE	FREQUENCY
DL	LEVEL INCREMENTAL STEP VALUE	OUTPUT LEVEL
EXA	AC COUPLE	MODULATION [EXT INPUT]
EXD	DC COUPLE	MODULATION [EXT INPUT]
EXI	POLARITY INVERT	MODULATION [EXT INPUT]
EXN	POLARITY NORMAL	MODULATION [EXT INPUT]
FØ	FREQ RELATIVE OFF	FREQUENCY
F1	FREQ RELATIVE ON	FREQUENCY
FD	FREQ KNOB DOWN	FREQUENCY
FM	FM DEVIATION (MAIN SOURCE)	MODULATION [FM]
FMF	FM OFF	MODULATION [FM]
FMM	FM DEVIATION (MIX SOURCE)	MODULATION [FM]
FMO	FM ON	MODULATION [FM]
FN	MEMORY	MEMORY
FO	FREQ OFFSET	FREQUENCY
FR	FREQUENCY	FREQUENCY
FU	FREQ KNOB UP	FREQUENCY
GHZ	GHz	UNIT
HZ	Hz	UNIT
ID	FREQ INCREMENTAL STEP DOWN	FREQUENCY
IU	FREQ INCREMENTAL STEP UP	FREQUENCY
KHZ	kHz	UNIT
LØ	LEVEL RELATIVE OFF	OUTPUT LEVEL
L1	LEVEL RELATIVE ON	OUTPUT LEVEL
L2	LEVEL RESOLUTION 0.1 dB (1st digit)	OUTPUT LEVEL
L3	LEVEL RESOLUTION 1 dB (2nd digit)	OUTPUT LEVEL
L4	LEVEL RESOLUTION 10 dB (3rd digit)	OUTPUT LEVEL
LD	LEVEL KNOB DOWN	OUTPUT LEVEL

Device Message in Alphabetic Order (3/4)

Program code	Parameter	Classification
LID	LEVEL INCREMENTAL STEP DOWN	OUTPUT LEVEL
LIU	LEVEL INCREMENTAL STEP UP	OUTPUT LEVEL
LO	LEVEL OFFSET	OUTPUT LEVEL
LU	LEVEL KNOB UP	OUTPUT LEVEL
M1	MOD MAIN SOURCE 1 kHz	MODULATION
M3	MOD MAIN SOURCE 400 Hz	MODULATION
M5	MOD MAIN SOURCE AF	MODULATION
M7	MOD MAIN SOURCE EXT	MODULATION
MD	MOD STEP DOWN	MODULATION
MHZ	MHz	UNIT
MU	MOD STEP UP	MODULATION
MV	mV	UNIT
OL	LEVEL	OUTPUT LEVEL
OLDBM	LEVEL UNIT CHANGE to dBm	OUTPUT LEVEL
OLDBU	LEVEL UNIT CHANGE to dB μ	OUTPUT LEVEL
OLV	LEVEL UNIT CHANGE to V or mV or μ V	OUTPUT LEVEL
PC	%	UNIT
R1	FREQ RESOLUTION 10 Hz	UNIT
R2	FREQ RESOLUTION 100 Hz	UNIT
R3	FREQ RESOLUTION 1 kHz	UNIT
R4	FREQ RESOLUTION 10 kHz	UNIT
R5	FREQ RESOLUTION 100 kHz	UNIT
R6	FREQ RESOLUTION 1 MHz	UNIT
R7	FREQ RESOLUTION 10 MHz	UNIT
RF	RF OFF	OUTPUT LEVEL
RL	RECALL	MEMORY
RO	RF ON	OUTPUT LEVEL
RP	RPP RESET	OUTPUT LEVEL
S1	MOD RESOLUTION 1st digit	MODULATION

Device Message in Alphabetic Order (4/4)

Program code	Parameter	Classification
S2	MOD RESOLUTION 2nd digit	MODULATION
S3	MOD RESOLUTION 3rd digit	MODULATION
SC	SKIP RESET	MEMORY
SK	SKIP	MEMORY
SM0	MOD MIX SOURCE OFF	MODULATION
SM5	MOD MIX SOURCE AF	MODULATION
SM7	MOD MIX SOURCE EXT	MODULATION
SP00	INITIAL SET	etc
SP01	BELL OFF	etc
SP02	BELL ON	etc
SP03	OPEN-CIRCUIT VOLTAGE DISPLAY (EMF)	OUTPUT LEVEL
SP04	TERMINATED VOLTAGE DISPLAY	OUTPUT LEVEL
ST	STORE	MEMORY
UV	μ V	UNIT
V	V	UNIT
0~9	NUMERAL 0~9	DATA
-	MINUS	DATA
.	DECIMAL POINT	DATA

APPENDIX B UNIVERSAL ASCII* CODE TABLE

BITS		B7 B6 B5		0 0		0 1		1 0		1 1		1 0		1 1						
B4	B3	B2	B1	CONTROL				NUMBERS SYMBOLS				UPPER CASE				LOWER CASE				
0	0	0	0	0	NUL	20	DLE	40	SP	60	0	100	@	120	P	140	,	160	p	
0	0	0	1	1	SOH	21	DC1	41	!	61	1	101	A	121	Q	141	a	161	q	
0	0	1	0	2	STX	22	DC2	42	"	62	2	102	B	122	R	142	b	162	r	
0	0	1	1	3	ETX	23	DC3	43	#	63	3	103	C	123	S	143	c	163	s	
0	1	0	0	4	EOT	24	DC4	44	\$	64	4	104	D	124	T	144	d	164	t	
0	1	0	1	5	ENQ	25	NAK	45	%	65	5	105	E	125	U	145	e	165	u	
0	1	1	0	6	ACK	26	SYN	46	&	66	6	106	F	126	V	146	f	166	v	
0	1	1	1	7	BEL	27	ETB	47	'	67	7	107	G	127	W	147	g	167	w	
1	0	0	0	8	BS	30	CAN	50	(70	8	110	H	130	X	150	h	170	x	
1	0	0	1	9	HT	31	EM	51)	71	9	111	I	131	Y	151	i	171	y	
1	0	1	0	10	LF	32	SUB	52	*	72	:	112	J	132	Z	152	j	172	z	
1	0	1	1	11	VT	33	ESC	53	+	73	;	113	K	133	[153	k	173	{	
1	1	0	0	12	FF	34	FS	54	,	74	<	114	L	134	\	154	l	174		
1	1	0	1	13	CR	35	GS	55	-	75	=	115	M	135]	155	m	175	}	
1	1	1	0	14	SO	36	RS	56	.	76	>	116	N	136	^	156	n	176	~	
1	1	1	1	15	SI	37	US	57	/	77	?	117	O	137	_	157	o	177	RUBOUT (DEL)	
				Address command	Universal command			Listen address				Talk address				Secondary address or command				

KEY octal

25	PPU
NAK	
hex 15	21

GP-IB code
ASCII character
decimal

* USA Standard Code for Information Interchange

APPENDIX C
GP-IB COMMAND COMPARISON TABLE
BETWEEN PACKET AND PC-9801

PACKET commands		With the PC-9801, < listener > and < talker > indicate addresses. Also, if commands are suffixed with @, EOI is set True.
WRITE	@ device number: expression	PRINT@[< listener > [< listener >]]: < data > , [< data >]
READ	@ device number: variable	INPUT @[< talker > , [< listener >]]: < variable >] Specified as < listener > < talker > for PACKET. RBYTE &H3F, < listener > , < talker > : < numeric variable > [< numeric variable >] numeric variable binary data
IFC	@ select code	ISET IFC[, < Integer notation >] Control is gained by executing this command. This is performed each time program is executed. Send time equal to or greater than < integer notation > × 100 μs
REN	@ select code	ISET REN
LCL	@ device number @ select code @ device number	WBYTE &H3F, < listener > , [secondary address]; WBYTE &H3F, < listener > , [secondary address], &H01;
COMMAND	@ select code	WBYTE [< command > : < data >] [@] transmission Since multiline messages cannot be transmitted in slave mode, the command is omitted and waited until the PC-9801 is addressed as the talker by the controller. RBYTE [< command > ; < numeric variable >] [@] reception Since multiline messages cannot be transmitted in slave mode, the command is omitted and waited until the PC-9801 is addressed as the listener by the controller.
TRG	@ device number	WBYTE &H3F, < listener > , [secondary address], &H08;
DCL	@ select code @ device number	WBYTE &H3F, &H14; WBYTE &H3F, < listener > , [secondary address], &H04;
LLO	@ select code	WBYTE &H3F, &H11;
PCT	@ device number	WBYTE < talker > , &H09;

PACKET commands

With the PC-9801, <listener> and <talker> indicate addresses. Also, if commands are suffixed with @, EOI is set True.

STATUS @ device number

WBYTE &H3F, &H1S, <listener>, <talker>, [secondary address], [status data]&H5F,&H19:

PPE @ device number

WBYTE &H3F, <listener>, [secondary address], &H05, H18, &H3F:

PPD @ select code
@ device number

WBYTE &H15;
WBYTE &H3F, <listener>, [secondary address], &H05, &H19, &H3F

SRQ @ select code
status value

ISSET SRQ
However, the status value is stored in variable STATUS.

LST@

PARITY@

GP-IB ADDRESS @

TERM IS character string

CMD DELIM = <delimiter code >

Delimiter code	0	1	2	3
Delimiter	C _R +L _F	C _R	L _F	EOL

ON-SRQ GOSUB

Specifies the first line number of the SRQ subroutine.
When <line number> = 0, SRQ reception is disabled.

POLL

Performs serial polling.

ISSET SRQ[@][N]

Performs parallel polling when N is specified.

SRQ OFF

Disables SRQ reception.

SRQ ON

Enables SRQ reception.

SRQ STOP

Stops SRQ reception temporarily. Only reception of messages logged. Linked to the SRQ subroutine when SRQ = ON.

LINE INPUT

Receives the string data sent from the specified talker and substitutes it for string variable.

PACKET commands	With the PC-9801, <listener> and <talker> indicate addresses. Also, if commands are suffixed with @, EOI is set True.
CMD TIMEOUT	Specifies the limit value of time-out check.
PPOLL	Assigns the line for outputting an answer to parallel polling.
CMD PPR	Specifies the PPR mode.

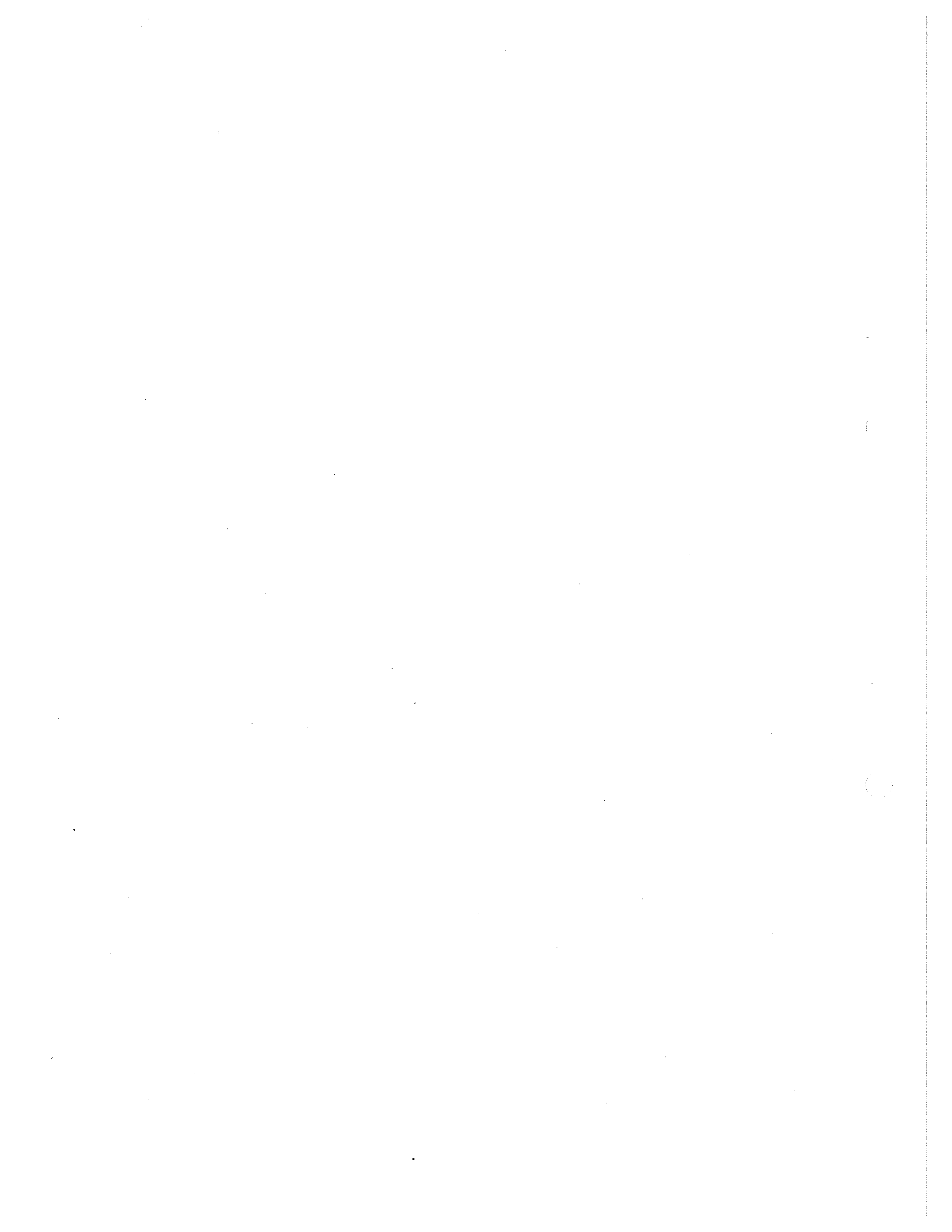

APPENDIX D

IEEE STANDARD ABBREVIATIONS INDEX

A		DIO	Data input/output
AC	DT	Device Trigger
ACDS	DTAS	Device Trigger Active State
ACG	DTIS	Device Trigger Idle State
ACRS			
AD	E		
AH	END	End
AIDS	EOI	End Or Identify
ANRS	EOS	End of String
APRS			
ATN	G		
AWNS	GET	Group execute Trigger
	State	GTL	Go to Local
C		gts	go to standby
C			
CACS	I		
CADS	IDY	Identify
CAWS	IFC	Interface Clear
CIDS	ist	Individual Status
CPWS			
	State	L		
CSBS	L	Listener
CSNS	LACS	Listener Active State
	State	LAD	Listener Address
CPPS	LADS	Listener Addressed State
CSRS	LAG	Listen Address Group
	State	LE	Extended Listener
CSWS	LIDS	Listener Idle State
	State	LLO	Local Lock Out
CTRS	LOCS	Local State
	State	lon	Listen only
D		LPAS	Listener Primary Addressed State
DAB			
DAC	lpe	Local Poll enabled
DAV	LPIS	Listener Primary Idle State
DC	ltn	Listen
DCAS	LWLS	Local with Lockout State
DCIS	lun	Local unlisten
DCL			
DD			
	Device Data			

M

MLA My Listen Address
 MSA My Secondary Address
 MTA My Talk Address

N

nba new byte available
 NDAC Not Data Accepted
 NPRS Negative Poll Response State
 NRFD Not Ready For Data
 NR Numeric Representation
 NUL Null Byte

O

OSA Other Secondary Address
 OTA Other Talk Address

P

PACS Parallel Poll Addressed to
 Configure State
 PCG Primary Command Group
 pof Power-off
 pon Power-on
 PP Parallel Poll
 PPAS Parallel Poll Active State
 PPC Parallel Poll Configure
 PPD Parallel Poll Disable
 PPE Parallel Poll Enable
 PPIS Parallel Poll Idle State
 PPR₁₋₈ Parallel Poll Response 1 ~ 8
 PPSS Parallel Poll Standby State
 PPU Parallel Poll Unconfigure
 PUCS Parallel Poll Unaddressed to
 Configure State

R

rdy Ready for next message
 REMS Remote State
 REN Remote Enable
 RFD Ready For Data
 RL Remote Local

rPP Request Parallel Poll
 RQS Request Service
 rsc Request system Control
 rsv Request service
 rtl Return to local
 RWLS Remote With Lockout state

S

SACS System Control Active State
 SCG Secondary Command Group
 SDC Selected Device Clear
 SDYS Source Delay State
 SE Secondary Message
 SGNS Source Generate State
 SH Source Handshake
 SIAS System Control Interface Clear
 Active State
 sic Send interface clear
 SIDS Source Idle State
 SIIS System Control Interface Clear
 Idle State
 SINS System Control Interface Clear
 Not Active State
 SIWS Source Idle Wait State
 SNAS System Control Not Active State
 SPAS Serial Poll Active State
 SPD Serial Poll Disable
 SPE Serial Poll Enable
 SPIS Serial Poll Idle State
 SPMS Serial Poll Mode State
 SR Service Request
 SRAS System Control Remote Enable
 Active State
 sre Send remote enable
 SRIS System Control Remote Enable
 idle State
 SRNS System Control Remote Enable
 not active State
 SRQ Service Request
 SRQS Service Request State
 ST Status
 STB Status Byte
 STRS Source Transfer State DAV to
 Low
 SWNS Source Wait for New cycle State
 SACS System Control Active State

T

T	Talker
TACS	Talker Active State
TAD	Talk Address
TADS	Talker Addressed State
TAG	Talker Addressed Group
tca	Take Control asynchronously
tcs	Take Control synchronously
TCT	Take Control
TE	Extended Talker
TIDS	Talker Idle State
ton	Talk only
TPAS	Talker Primary Addressed State
TPIS	Talker Primary Idle State

U

U	Uniline Message
UC	Universal Command
UCG	Universal Command Group
UNL	Unlisten
UNT	Untalk

